

# TX-W28R4F Service Manual

Safety

Specifications

Parts List

Service  
Information

Adjustments

Self Check

Service Hints

Mechanical  
View

Disassembly

Location of  
Controls

Waveforms

Block Diagrams

Schematic Diagrams

PCB Views

## Service Support

Service and repair of this product is supported by Panasonic's LUCI interface.

This interface provides a link between the TV and a standard PC to allow a number of diagnostic and control functions to be performed.

For more details contact your local Panasonic company.

  
BACK

EXIT

Audio

Control

Power supply

Video



BACK

E - PCB

M - PCB

Y - PCB



BACK

E - Schematic

H - Schematic

M - Schematic

Y - Schematic



BACK

# Service Manual



## TELEVISORE A COLORI

### TX-W28R4F

### Telaio EURO4

#### Specificazione

<b>Alimentazione:</b>	220-240V AC, 50Hz
<b>Consumo:</b>	105W
<b>Impedenza dell'antenna:</b>	75Ω non bilanciata
<b>Consumo in Stand-by:</b>	1,8W
<b>System di Ricezione:</b>	CCIR 625 Linee PAL-I, B/G, H, D/K, PAL-525/60 SECAM L/L', B/G, D/K M.NTSC NTSC (Solo ingresso AV)
<b>Canali Ricezione:</b>	VHF E2-E12 VHF H1-H2 (ITALY) VHF A-H (ITALY) VHF R1-R2 VHF R3-R5 VHF R6-R12 UHF E21-E69 CATV (S01-S05) CATV S1-S10 (M1-M10) CATV S11-S20 (U1-U10) CATV S21-S41 (HYPER)
<b>Frequenze Intermedie:</b>	Video 38,9MHz, 34MHz Sound 32,9MHz, 33,4MHz, 33,16MHz 32,4MHz, 40,4MHz, 33,05MHz 32,66MHz
<b>Colore</b>	34,47MHz (PAL) 34,5MHz, 34,65MHz (SECAM)
<b>Prese Video/Audio:</b>	
USCITA AUDIO MONITOR	Audio (RCAx2) 500mV rms 1kΩ
INGRESSO AV1	Video (21 pin) 1V p-p 75Ω Audio (21 pin) 500mV rms 10kΩ RVB (21 pin)
USCITA AV1	Video (21 pin) 1V p-p 75Ω Audio (21 pin) 500mV rms 1kΩ

INGRESSO AV2	Video (21 pin) 1V p-p 75Ω Audio (21 pin) 500mV rms 10kΩ S-Video IN Y: 1V p-p 75Ω (21-pin) C: 0.3V p-p 75Ω
--------------	--

USCITA AV2	Video (21 pin) 1V p-p 75Ω Audio (21 pin) 500mV rms 1kΩ Uscita selezionabile (21 pin)
------------	--

INGRESSO AV3	S-Video IN Y: 1V p-p 75Ω (4-pin) C: 0,3V p-p 75Ω Audio (RCAx2) 500mV rms 10kΩ Video (RCAx1) 1V p-p 75Ω
--------------	---

<b>Tensione all'anodo:</b>	30,5kV ±1kV
<b>Tubo Catodico:</b>	W66EHK51X35 66cm
<b>Potenza Audio:</b>	2 x 20W (Musicali) 8Ω Impedenza
<b>Cuffia:</b>	8Ω Impedenza
<b>Accessori:</b>	Telecomando 2 x R6 (UM3) Batterie
<b>Dimensioni:</b>	
Altezza:	518mm
Larghezza:	760mm
Profondità:	496,8mm
<b>Peso netto:</b>	35,5kg

Le caratteristiche possono variare senza preavviso.  
Peso e dimensioni sono approssimate.

**NOTA:** Per maggiori informazioni consultare la guida tecnica del telaio EURO-4.

# Indice

Norme di sicurezza.....	2
Consigli per l'assistenza.....	3
Service Mode .....	4
Procedura di taratura.....	5
Forma D'onda.....	6
Valori di allineamento .....	7
Schema a blocchi.....	8
Ubicazione Dei Componenti.....	12
Elenco Parti Di Ricambio.....	13
Schema Elettrico .....	22
Vista Lato Componenti .....	26

## Norme di sicurezza

### Precauzioni

1. E'Consigliabile utilizzare un trasformatore di isolamento prima di eseguire ogni intervento sul telaio.
2. Durante l'assistenza, verificare lo stato dei conduttori specialmente nei circuiti ad alta tensione. In caso di corto circuito, sostituire tutti le parti surriscaldate o danneggiate.
3. Dopo l'assistenza, assicurarsi che tutti gli accorgimenti di protezione (isolatori, schermi, isolatore R-C, ecc) siano correttamente installati.
4. Quando il televisore non viene utilizzato per lunghi periodi, scollegarlo dalla rete.
5. Alta tensione 31,5kV è presente quando il televisore è in funzione. Utilizzare il televisore senza il pannello posteriore comporta il pericolo di scosse elettriche dai circuiti di alimentazione. L'assistenza deve essere eseguita solo da personale specializzato a conoscenza delle necessarie precauzioni da adottare. Prima di intervenire sul cinescopio, scaricare a massa l'anodo dello stesso.
6. Dopo l'assistenza assicurarsi di eseguire le seguenti prove di dispersione per prevenire rischi di scossa elettrica all'utente.
5. Invertire la presa AC di alimentazione e ripetere le misure precedenti.
6. Il potenziale in ogni punto non deve superare 1,4V rms, in caso superi questo valore, c'è pericolo di scossa elettrica e il televisore deve essere riparato e controllata prima di essere riconsegnato al proprietario.

### Esempio di collegamento per la dispersione a caldo

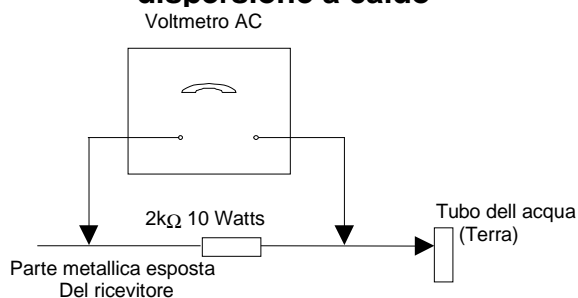

Fig. 1.

### Controllo a freddo di dispersione

1. Disinserire il cavo di alimentazione e corto circuitare i due terminali.
2. Azionare l'interruttore di accensione.
3. Collegare uno strumento per la misure di resistenza con segue un puntale sulla spina del cavo di alimentazione e l'altro sul telaio del televisore o su una parte metallica (ad esempio viti) collegate telaio. Se la parte metallica ha un collegamento col telaio la lettura dovrà essere compresa tra i valori 4MΩ e 20MΩ, se la parte metallica non ha un collegamento con il telaio la lettura dovrà essere.

### Controllo a caldo di dispersione

1. Inserire la spina nella presa di corrente. Non usare un trasformatore di isolamento per questo controllo.
2. Collegare una resistenza da 2kΩ 10W in serie con una parte metallica esterna del televisore e con un punto di terra (esempio: tubi dell'acqua).
3. Utilizzare un voltmetro AC con sensibilità 1000Ω/Volt o più per misurare il potenziale ai capi della resistenza.
4. Verificare ogni parte metallica esterna misurando la tensione ogni volta.

### Radiazioni raggi X

#### Precauzioni:

1. La sezione ad alta tensione e il cinescopio sono sorgenti di raggi X.
2. In caso di utilizzo di una sonda per alta tensione, assicurarsi che la stessa sopporti 31,5kV senza pericolo di emissione di raggi.

**NOTA:** E'importante verificare periodicamente la funzionalità del misuratore di tensione.

1. Regolare la luminosità al minimo.
2. Misurare l'alta tensione. La lettura dovrà essere 30,5kV ± 1kV. (se è necessario un immediato intervento tecnico per prevenire danni.)
3. Per prevenire la possibilità di emissione di raggi X, è indispensabile utilizzare il cinescopio specificato.

## Consigli per l'assistenza

### Come rimuovere il pannello posteriore

1. Rimuovere le 11 viti (A) come indicato in Fig.2.

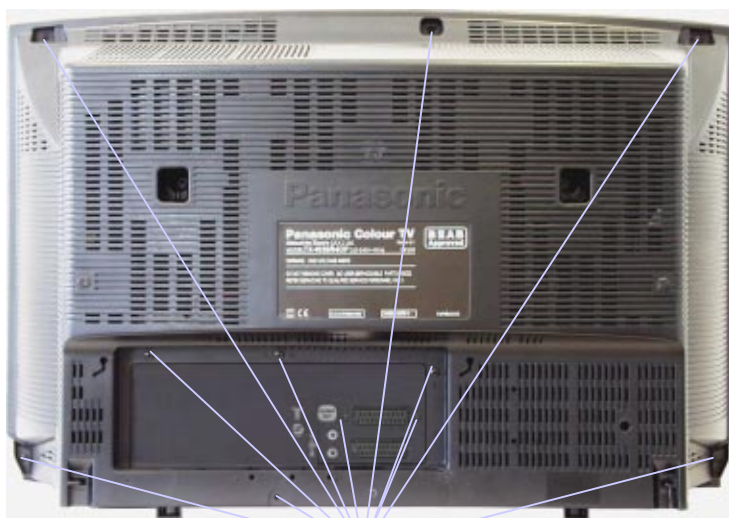

Viti A  
Fig.2.

## Ubicazione dei Controlli

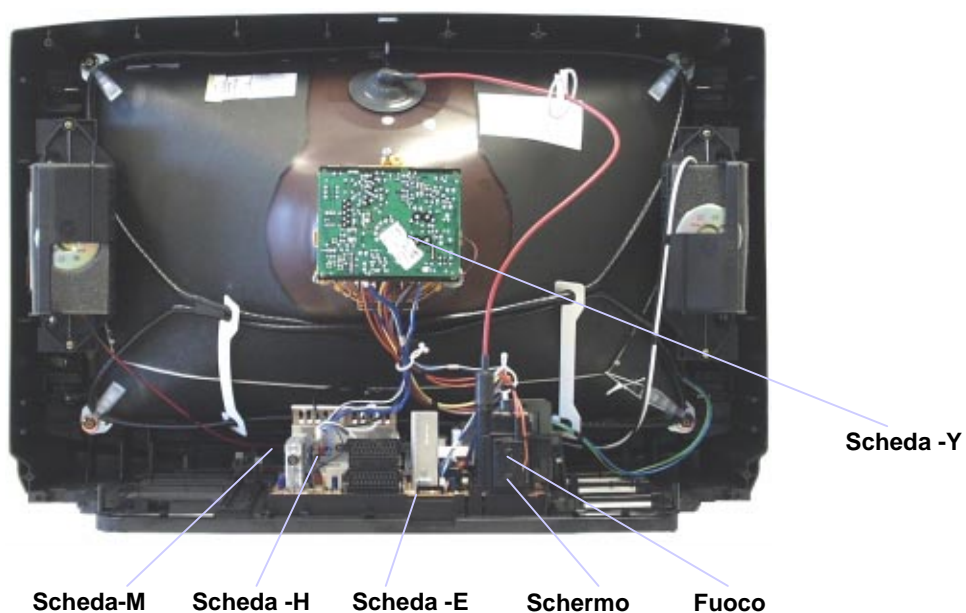

Fig.3.

## Service Mode

Il telecomando serve anche per impostare e memorizzare le regolazioni con l'eccezione della regolazione di cut-off che deve essere sempre fatta precedentemente alle regolazioni di servizio.

Eseguire le regolazioni in accordo con il display sullo schermo. Il display sullo schermo mostra le variazioni approssimative della CPU.

1. Regolare I toni bassi nella massima posizione, regolare I toni alti nella minima posizione, premere il tasto volume meno sulla tastiera del TV, e nello stesso tempo premere il tasto **"INDEX"** sul telecomando.
2. Premere I tasti **ROSSO** o **VERDE** per selezionare le Funzioni.
3. Premere I tasti **GIALLO** o **BLU** per modificare I valori.
4. Premere I tasto **"STR"** sulla tastiera del TV per memorizzare la regolazione eseguita.
5. Per uscire dal service mode occorre premere il tasto **"N"** sul telecomando.

Come utilizzare il TELECOMANDO SERVICE, codice di ricambio TZS2EK004. Per accedere al Service 1 premere il tasto **"Service"** e il programma zero. Il tv si posizionerà immediatamente nel Service 1. Premere I tasti **ROSSO** o **VERDE** per selezionare le funzioni. Premere I tasti **GIALLO** o **BLU** per modificare I valori.

**NOTA:** Questo TV ha l'opzione per utilizzare la "Memory Pack", che vi permette di trasferire I canali sintonizzati nel TV e viceversa. La "Memory Pack" si puo' utilizzare solo con il telaio "EURO-4".

## Come usare la memory pack

### Procedura da TV a unita' di memoria

1. Inserire l'unita' di memoria nella presa a 21 pin. Inferiore a tergo del TV, ed accendere il TV.
2. Entare nel service mode come da spiegazione sopra riportata. Lo schermo visualizzera' :-

Program  
External>>TV

3. Premere il tasto **BLU** sul telecomando, lo schermo TV visualizza :-

Program  
TV>>External

4. Premere il tasto **STR** (archivio) sul telecomando, lo schermo TV visualizza :-

Please Wait

5. Tutti I dati di sintonia archiviati nel TV vengono trasferiti nell 'unita di memoria. Questa procedura richiede 2-3 minuti, ed al termine lo schermo visualizza :-

Complete

### Procedura da unita' di memoria a tv

1. Inserire l'unita' di memoria nella presa a 21 pin. Inferiore a tergo del TV, ed accendere il TV.
2. Entare nel service mode come da spiegazione sopra riportata. Lo schermo visualizzera' :-

Program  
External>>TV

3. Premere il tasto **STR** (archivio) sul telecomando, lo schermo TV visualizza :-

Please Wait

4. Tutti I dati di sintonia archiviati nel 'unita' di memoria vengono copiati nel "TV". Questa procedura richiede 2-3 minuti, ed al termine lo schermo visualizza :-

Complete

5. I dati di sintonizzazione prelevati dal 'unita' di memoria sono stati copiati nel TV.
6. Per uscire dal service mode occorre premere il tasto **"N"** sul telecomando.
7. La procedura e' terminata, rimuovere l'unita' di memoria.

## ERRORI

Se usando la **"MEMORY PACK"** avviene un errore il TV lo rilevera' e sullo schermo apparira' la scritta :-

Error !!

Se questo succede, spegnere il TV e poi ripetere l'operazione. Se si ripete l'errore controllare I collegamenti e la batteria da 9 Volt Nella **"MEMORY PACK"**.

## Procedura di taratura

TARATURE/PREPARAZIONE	REGOLAZIONE												
<b>REGOLAZIONE +B</b> 1. Ricevere un segnale a barre colori. 2. Predisporre i controlli :- Luminosita'      minimo  Contrasto        minimo  Volume            minimo	1. Con il trimmer <b>R811</b> regolare la tensione <b>B2</b> per $148V \pm 1V$ . 2. Confermare le seguenti alimentazioni <table style="width: 100%; border: none;"> <tr> <td><b>B9</b> 5 ± 0,25V</td> <td><b>B10</b> 5 ± 0,25V</td> </tr> <tr> <td><b>B5</b> 12 ± 0,5V</td> <td><b>B11</b> 33 ± 1,5V</td> </tr> <tr> <td><b>B4</b> 16 ± 1V</td> <td><b>B7</b> 8 ± 0,5V</td> </tr> <tr> <td><b>B12</b> 26 ± 1V</td> <td><b>B8</b> 5,5 ± 0,5V</td> </tr> <tr> <td><b>B3</b> 41 ± 1V</td> <td><b>B13</b> 15 ± 1V</td> </tr> <tr> <td><b>B1</b> 200 ± 10V</td> <td><b>B14</b> -15 ± 1V</td> </tr> </table>	<b>B9</b> 5 ± 0,25V	<b>B10</b> 5 ± 0,25V	<b>B5</b> 12 ± 0,5V	<b>B11</b> 33 ± 1,5V	<b>B4</b> 16 ± 1V	<b>B7</b> 8 ± 0,5V	<b>B12</b> 26 ± 1V	<b>B8</b> 5,5 ± 0,5V	<b>B3</b> 41 ± 1V	<b>B13</b> 15 ± 1V	<b>B1</b> 200 ± 10V	<b>B14</b> -15 ± 1V
<b>B9</b> 5 ± 0,25V	<b>B10</b> 5 ± 0,25V												
<b>B5</b> 12 ± 0,5V	<b>B11</b> 33 ± 1,5V												
<b>B4</b> 16 ± 1V	<b>B7</b> 8 ± 0,5V												
<b>B12</b> 26 ± 1V	<b>B8</b> 5,5 ± 0,5V												
<b>B3</b> 41 ± 1V	<b>B13</b> 15 ± 1V												
<b>B1</b> 200 ± 10V	<b>B14</b> -15 ± 1V												
<b>CUT OFF / Ug2 Test</b> 1. Ricevere un segnale a barre colori. 2. Smagnetizzare il cinescopio esternamente. 3. Entrare nel SERVICE Mode 1. 4. Selezionare CUT-OFF .	Per regolare il cutoff collegare la sonda sul blu, e regolare con il tasto giallo o blu per 160 V, premere <b>STR</b> . Selezionare Ug2 e regolare la VR per visualizzare O.K..												

## SELF CHECK (auto diagnosi)

Il SELF CHECK é usato per testare le linee "BUS" ed il codice esadecimale del TV. Per richiamare il SELF-CHECK occorre premere il tasto di "**STATUS**" sul telecomando e contemporaneamente il tasto (-) sul TV. Attenzione: quando si richiama il Self-check, il TV verrà resettato ritornando alle condizioni di fabbrica, cancellando i canali sintonizzati dal cliente. Sullo schermo apparirà la seguente in tabella :

VDP	O.K.	PCB	O.K.
TUN	O.K.	Cab	O.K.
E2	O.K.	Sum	Solo per la fabbrica
MSP	O.K.		
DPL	--		
OPTION 1	39		
OPTION 2	5D		
OPTION 3	3F		
OPTION 4	00		
OPTION 5	FF		
OPTION 6	25		

Se uno degli ingressi/uscite della "CPU" e' riconosciuta come incorretta, sullo schermo apparira' "--" invece di "OK".

### Materiale di supporto per l'assistenza TV.

- **LUCI** interface kit (Linked Utility Computer Interface)  
 Il kit contiene l'interfaccia, i cavi per la connessione al TV e al PC, il software per il diagnostico.  
 Ogni volta che verrà introdotta una nuova gamma di modelli sarà disponibile il nuovo software aggiornato.
- **VICI** (Visual Interactive Computer Information)  
 Questi C.D. rom contengono le seguenti informazioni:
  1. Service Manual
  2. Libretti di istruzioni (anche in lingua italiana)
  3. Informazioni tecniche
- **TASMIN** (Technically Advanced System for Multimedia Interactive Notes)  
 Rappresenta il primo passo per avere informazioni tecniche più velocemente ed in modo interattivo.

# FORMA D'ONDA

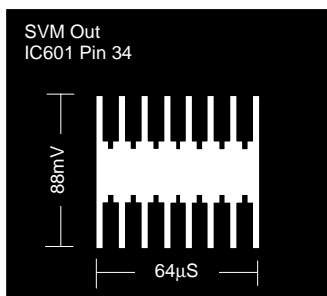
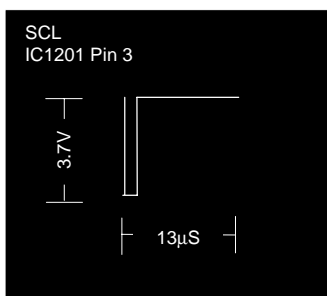
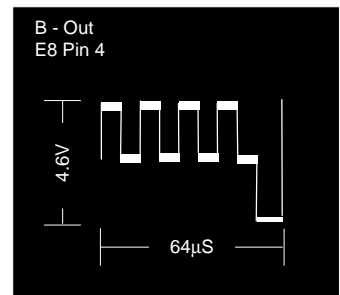
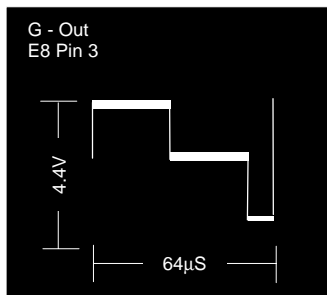
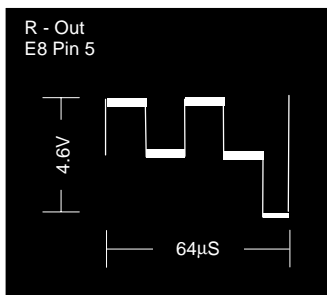
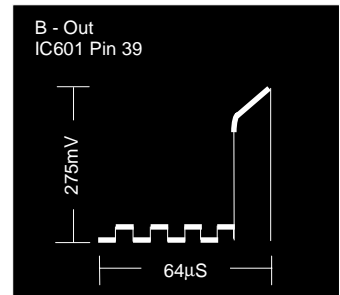
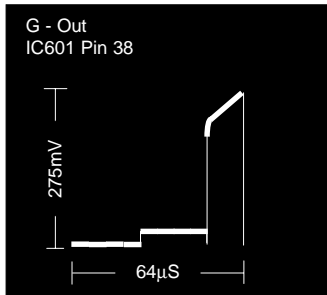
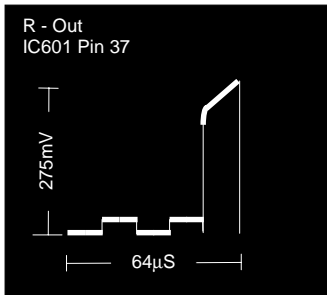
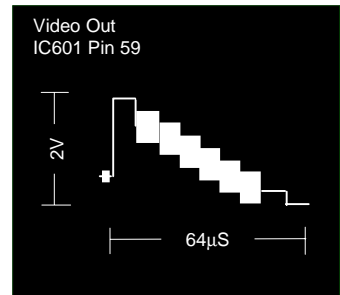
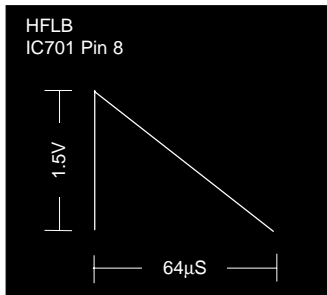
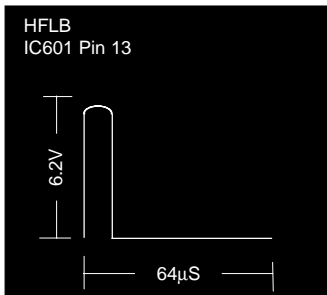
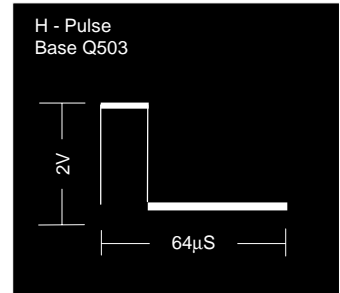
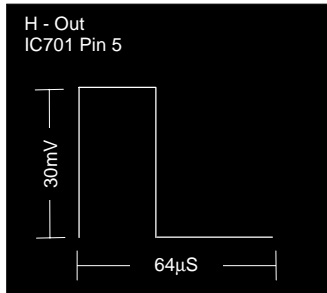
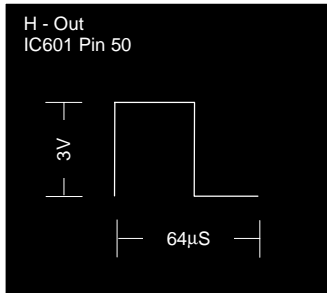
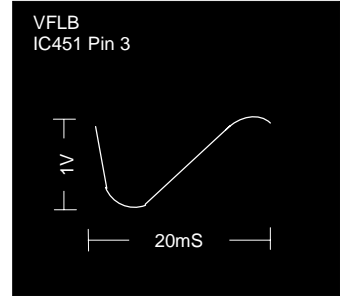
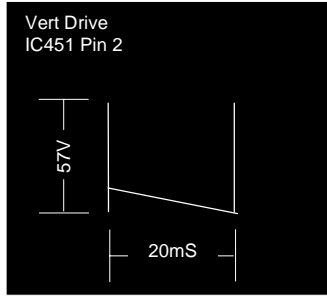
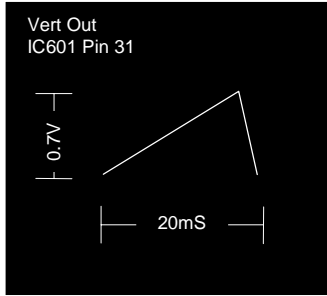



## Valori di allineamento, esempi:

(N.B. I valori indicati sullo schermo sono approssimative.)

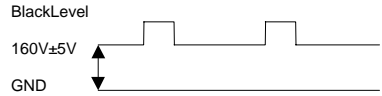
Funzione	Valori indicativi	Impostazioni
Posizione orizz	H-Pos 061	Posizione ottimale.
V-Pos	V-Pos 005	Posizione ottimale.
Ampiezza orriz	H-Amp 055	Posizione ottimale.
Ampiezza vert	V-Amp 054	Posizione ottimale.
EO-ampiezza	EW-Amp 1 -128	Posizione ottimale.
EO-ampiezza	E/W-Amp 2 006	Posizione ottimale.
Correz-trapezoidale	Trapez-1 047	Posizione ottimale.
Correz-trapezoidale	Trapez-2 -128	Posizione ottimale.
Linearita vert	V-Lin 006	Posizione ottimale.
Simmetria verticale	V-Sym 002	Posizione ottimale.
DVCO	DVCO -005	Premere il tasto <b>blu</b> , poi <b>STR</b> .
Cutoff	Cut-off 0171	<p>Per regolare il cutoff collegare la sonda sul blu, e regolare con il tasto <b>giallo</b> o <b>blu</b> per 160V, premere <b>STR</b>. Selezionare Ug2 e regolare la VR per visualizzare ok.</p> 
Ug2 Test	Ug2 055 O.K.	
Highlight Lowlight	High 0902 0777 0864 Low 0117 0132 0112	Posizione ottimale.
Sub-Brightness	Sub-Brightness 255	Posizione ottimale.

# SCHEMA A BLOCCHI SEGNALI VIDEO

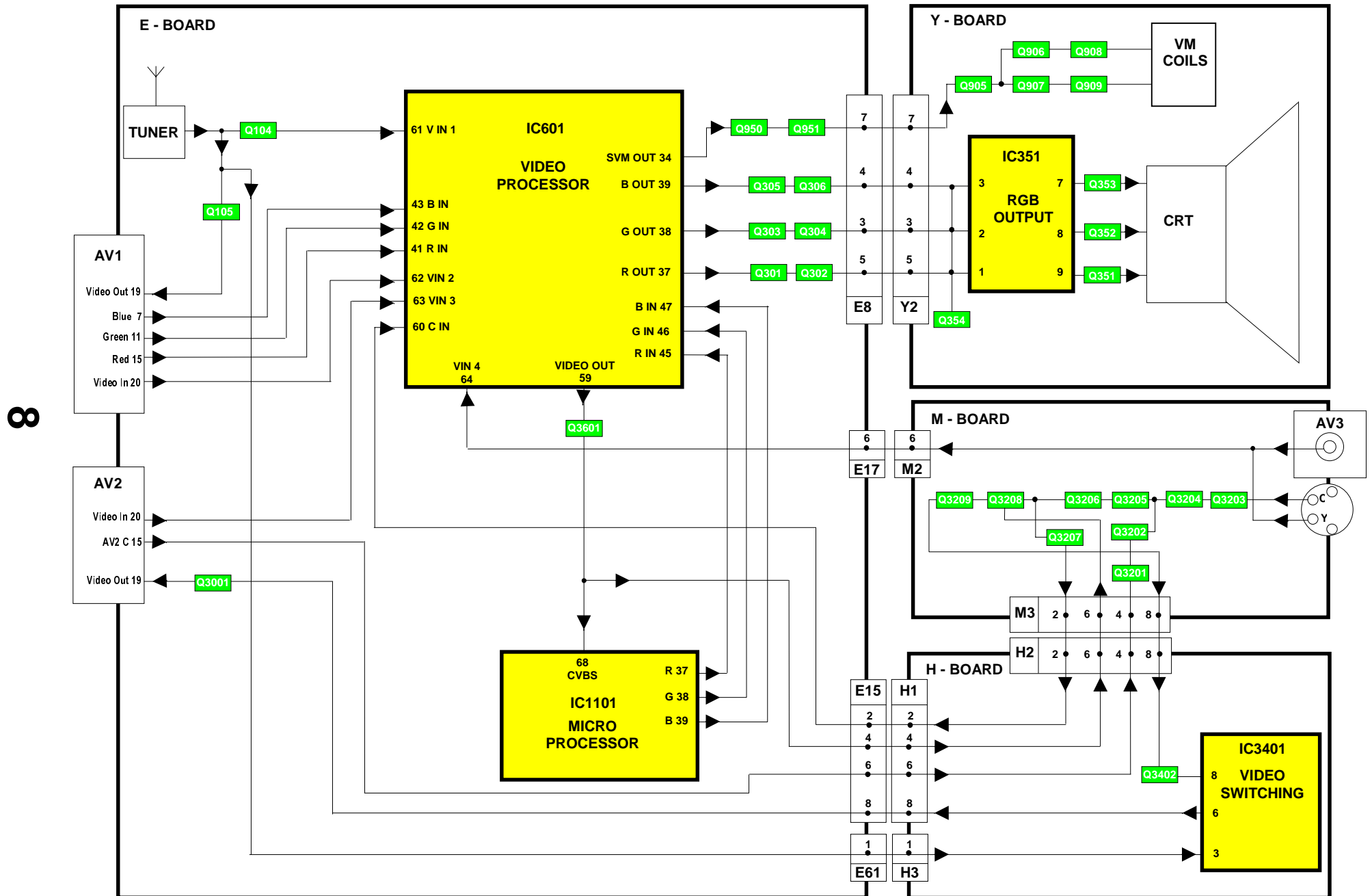

# SCHEMA A BLOCCHI SEGNALI AUDIO

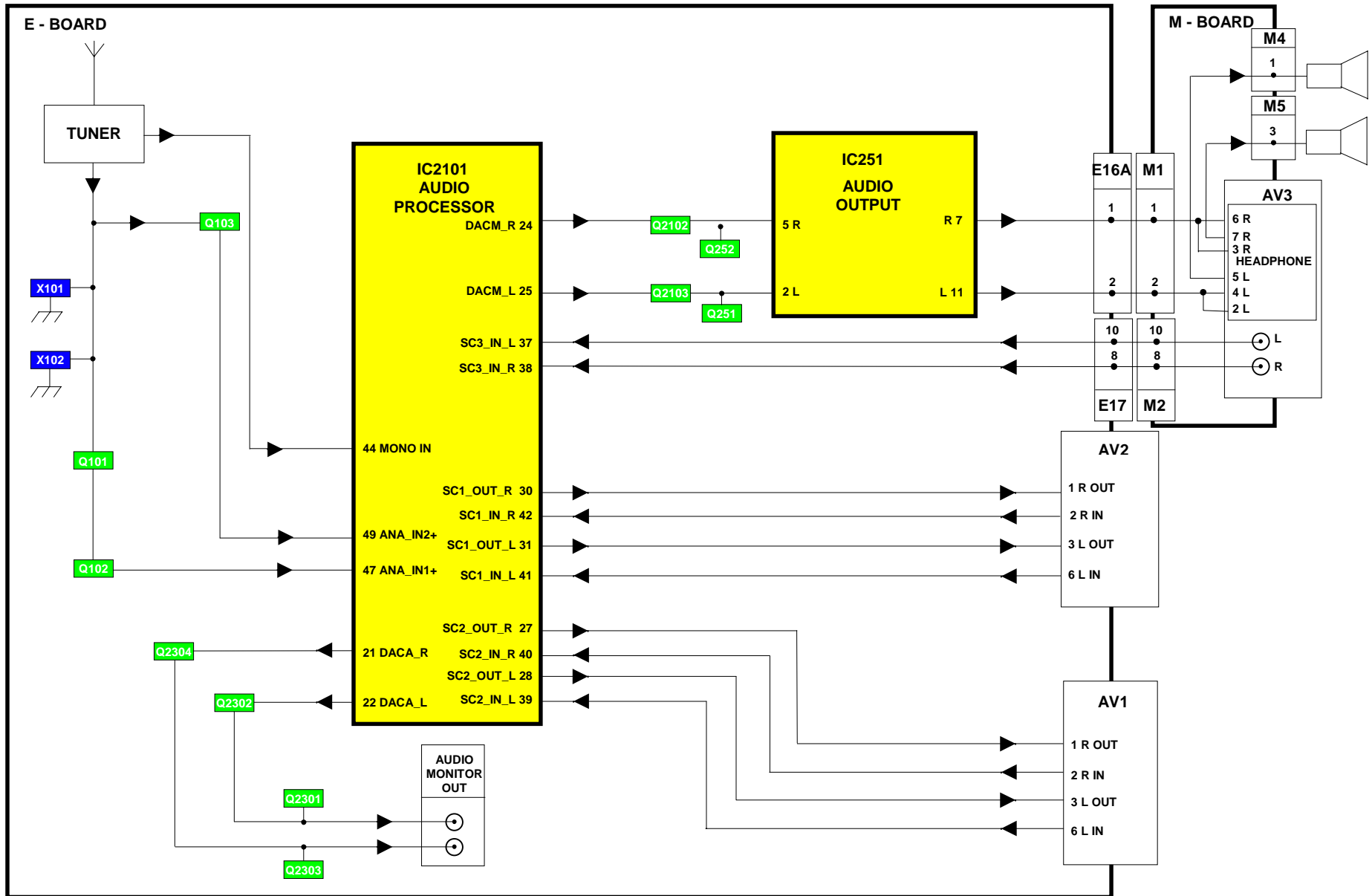

# SCHEMA A BLOCCHI LINEE DI CONTROLLO

10

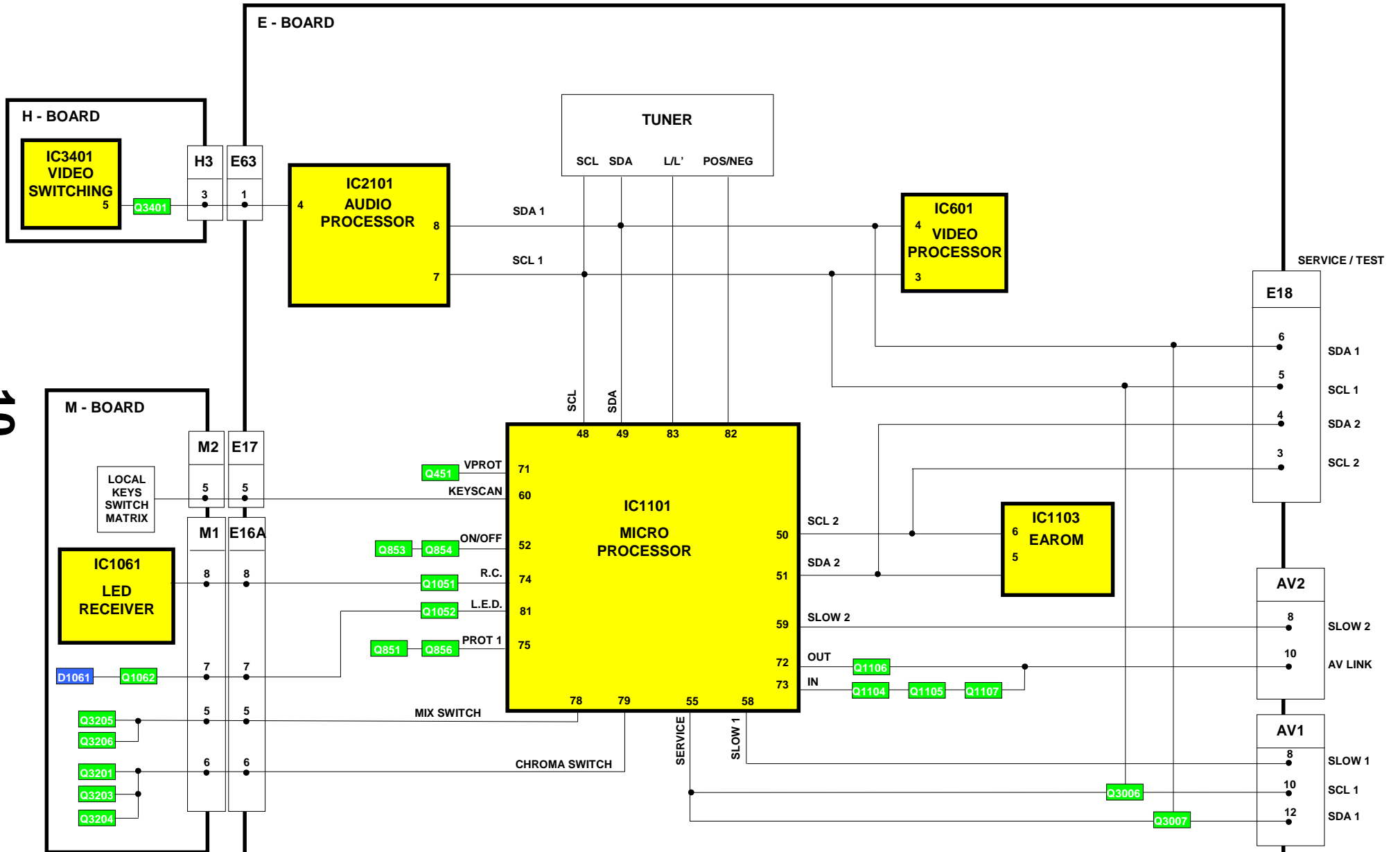

# SCHEMA A BLOCCHI POTENZA ALIMENTAZIONE

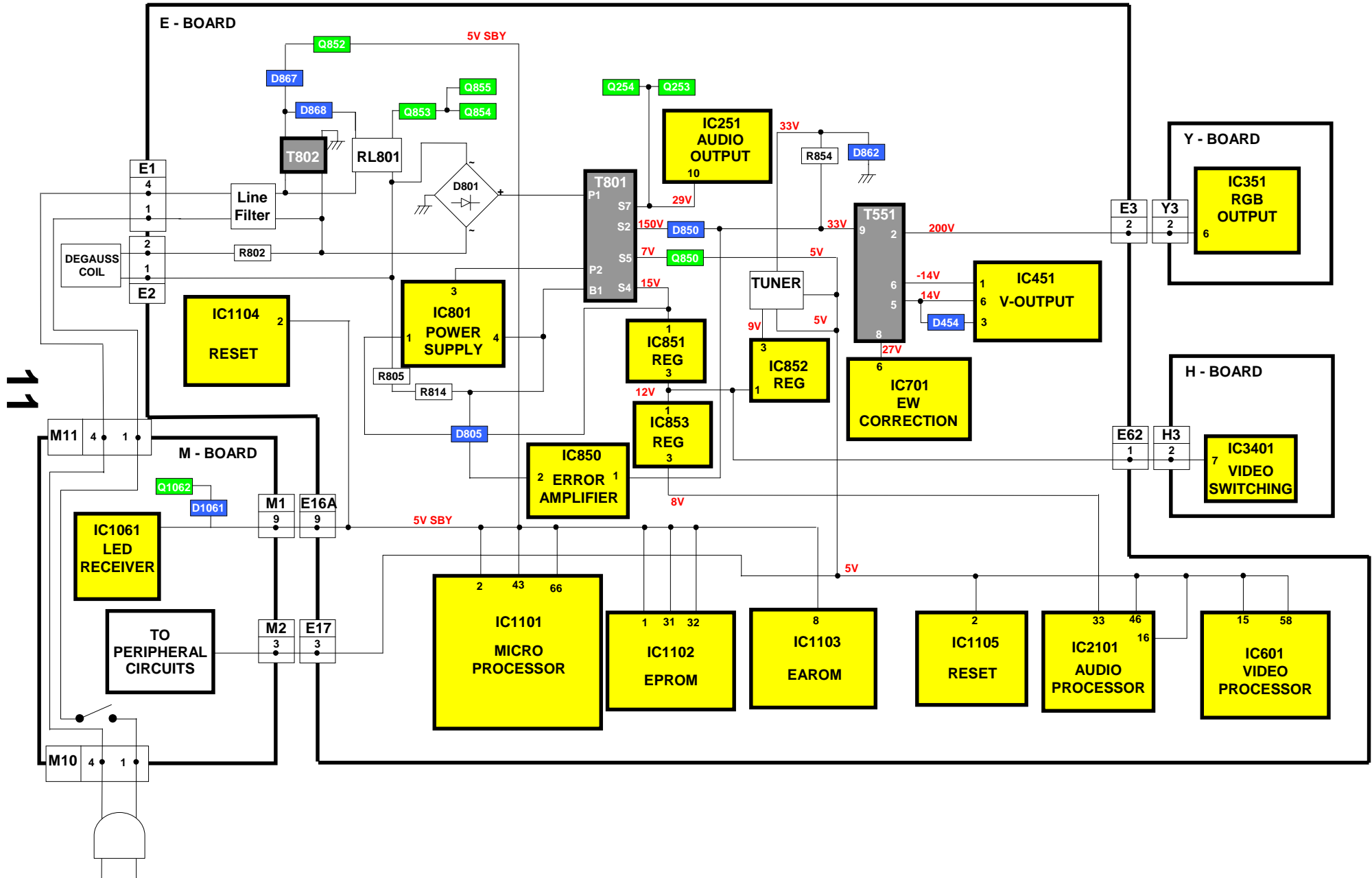

# UBICAZIONE DEI COMPONENTI

**NOTA:**

In questa pagina numeri all' interno di un cerchio corrispondono ai numeri riportanti nell'elenco parti di ricambio.

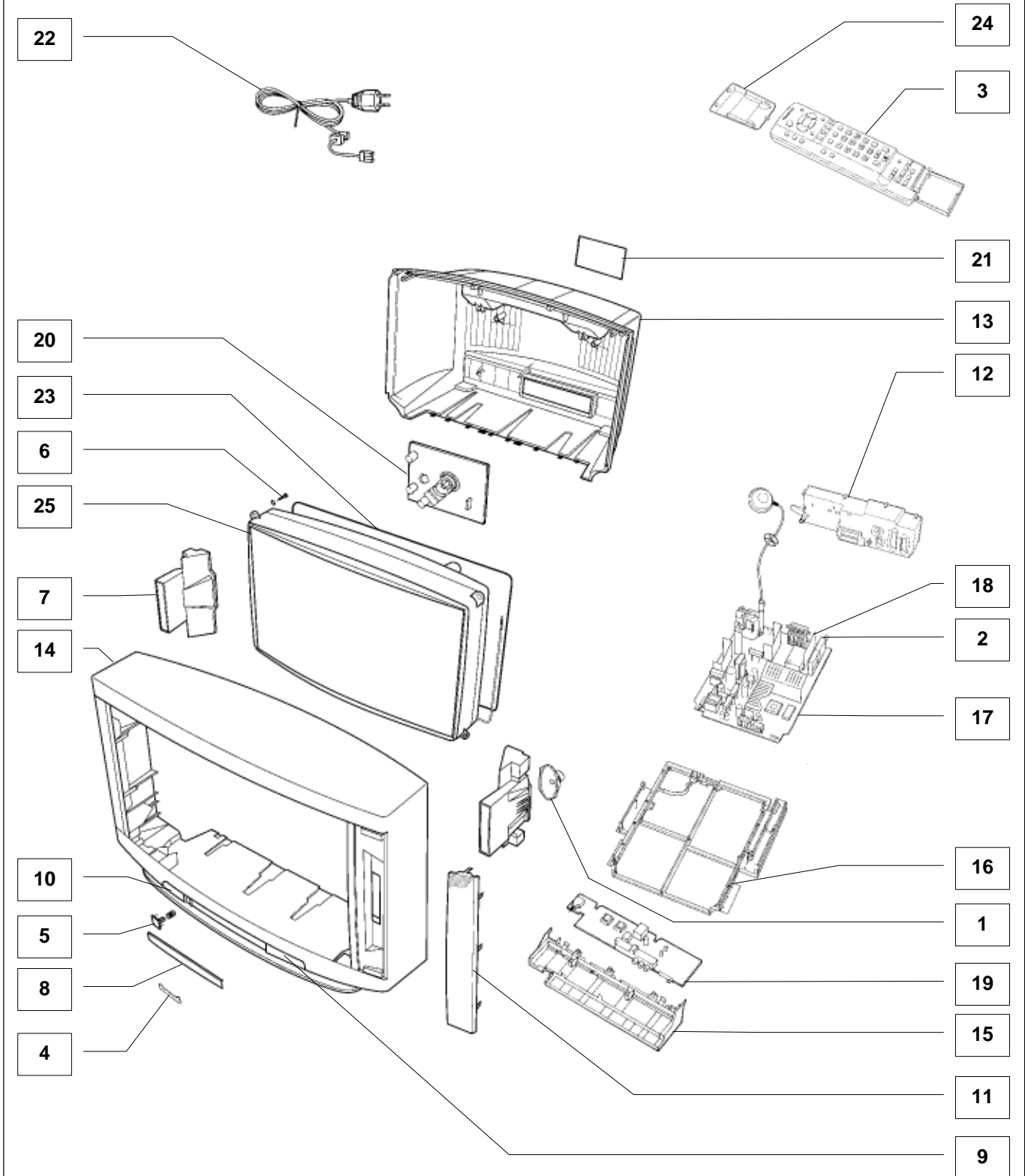

















# ELENCO PARTI DI RICAMBIO

## Nota

Componenti contrassegnati  sono di sicurezza e devono essere sostituiti solo con quelli specificati.

\* Quando ordinate questi ricambi, dovete assolutamente sempre riportare il modello esatto e completo del TV riportato nell'etichetta posteriore del televisore.

Cct Ref	Parts Number	Description
<b>MECHANICAL PARTS</b>		
1	EAGG1218J2	SPEAKER
2	ENG29505G	TUNER 
3	EUR511210	REMOTE CONTROL
4	TBM8E1728	PANASONIC BADGE
5	TBX8E049	POWER BUTTON
6	THT1062	CRT FIXING SCREW
7	TKK8E026	SPEAKER REFLECTOR
8	TKP8E1141	DOOR LID
9	TKP8E1142	PANEL RIGHT
10	TKP8E1143	PANEL LEFT
11	TKP8E1152	SPEAKER NET
12	TKP8E1254	AV PANEL
13	TKU8E00300	BACK COVER 
14	TKY8E120	CABINET 
15	TMW8E024-3	CONTROL BRACKET
16	TMX8E031	CHASSIS FRAME
17	TNP8EE009BH	E P.C.B. 
18	TNP8EH002AB	H P.C.B. 
19	TNP8EM013AB	M P.C.B. 
20	TNP8EY012AE	Y P.C.B. 
21	TQF8E2677	MODEL LABEL 
22	TSX8E0027	POWER CORD 
23	TXFLK01DAG	DEGAUSS COIL 
24	UR51EC904A	BATTERY COVER (REMOTE)
25	W66EHK51X35	C.R.T. 
<b>MISCELLANEOUS COMPONENTS</b>		
	31221212478	FIX CLIP
	832AG11D-ESL	I.C. SOCKET
	F9-4-220	RELAY
	PCS-084A-1	84 PIN SOCKET
	TBM8E1532-2	PRESET PANEL
	TBM8E1886	REAR AV LABEL
	TEK6940	LID CATCH
	TMW8E017	LED HOLDER
	TPC8E4676	OUTER CARTON
	TPD8E623	TOP CUSHION
	TPD8E624	BOTTOM CUSHION
	UM-3DJ-2P	BATTERY PACK
	ZTUZAE550A	ANODE LEAD 
RL801	TSE1885-1	RELAY 
R802	232266296706	THERMISTOR 
S351	0330550049	CRT SOCKET
<b>INSTRUCTION BOOKS</b>		
	TQB8E2569A	GERMAN 
	TQB8E2569BD	DUTCH/FRENCH 
	TQB8E2569CE	ITALIAN/SPANISH 
	TQB8E2569FG	SWEDISH/NORG. 
	TQB8E2569HK	SUOMI/DANISH 
<b>I.C.s</b>		
IC251	LA4282	AUDIO OUTPUT

Cct Ref	Parts Number	Description
IC351	TDA6103Q-N3	R.G.B. OUTPUT
IC451	LA7845N	VERTICAL OUTPUT
IC601	VDP3120BPPB1	VIDEO PRCESSOR
IC701	TEA2031A	E/W CORRECTION
IC801	STRF6654LF51	POWER SUPPLY
IC850	SE140N	ERROR AMPLIFER
IC851	L78M12MRB	12V REGULATOR
IC852	L78M09MRB	9V REGULATOR
IC853	AN78L08TA	8V REGULATOR
IC1061	RPM-637CBRS1	LED RECEIVER
IC1101	SDA5450C48	MICRO PROCESSOR
IC1102	27C2001-F17	EPROM *
IC1103	XGL2-01LF	EAROM *
IC1104	MN1381-R(TA)	RESET
IC1105	MN1381-T(TA)	RESET
IC2101	MSP3410DPOB4	AUDIO PROCESSOR
IC3401	TEA2114	VIDEO SWITCHING
<b>FUSES</b>		
F802	19181-3.15	FUSE 
F8021	EYF52BC	FUSE HOLDER
F8022	EYF52BC	FUSE HOLDER
<b>DIODES</b>		
D101	MA3020TX	DIODE
D102	MA3020TX	DIODE
D251	MA2180TP	DIODE
D253	MA700TA5	DIODE
D254	MA700TA5	DIODE
D354	1SR124-4AT82	DIODE
D355	1SR124-4AT82	DIODE
D356	1SR124-4AT82	DIODE
D357	MA165TA5	DIODE
D358	MA165TA5	DIODE
D359	MA165TA5	DIODE
D360	MTZJT-7715A	DIODE
D361	MA165TA5	DIODE
D362	MA165TA5	DIODE
D363	MA165TA5	DIODE
D364	MA165TA5	DIODE
D453	MA165TA5	DIODE
D454	ERA15-02V3	DIODE
D456	MTZJT-775.6C	DIODE
D457	MA165TA5	DIODE
D501	MA165TA5	DIODE
D502	1SR124-4AT82	DIODE
D511	MA4047	DIODE
D551	ERD07-15L7	DIODE
D552	RU3LFA1	DIODE
D553	1SR124-4AT82	DIODE
D554	1SR124-4AT82	DIODE
D556	MA165TA5	DIODE
D557	EU02	DIODE
D558	1SR124-4AT82	DIODE

Cct Ref	Parts Number	Description
D601	DAN217T146	DIODE
D603	DAN217T146	DIODE
D605	DAN212KT146	DIODE
D606	MA165TA5	DIODE
D607	MA4051	DIODE
D609	1SR124-4AT82	DIODE
D615	STZ6.2NT146	DIODE
D616	STZ6.2NT146	DIODE
D701	MA165TA5	DIODE
D702	MTZJT-775.6C	DIODE
D704	MA29TA5	DIODE
D705	MTZJT-775.6B	DIODE
D801	RBV-608LF-B	DIODE
D803	1SR124-4AT82	DIODE
D804	1SR124-4AT82	DIODE
D805	TLP621GR-LF2	PHOTO COUPLER
D806	1SR124-4AT82	DIODE
D850	RU4BLF-L1	DIODE
D851	MTZJT776.2B	DIODE
D852	MA165TA5	DIODE
D853	MA2180BLFS	DIODE
D854	TVSRU2AMLFA5	DIODE
D855	FML22SLF610	DIODE
D856	RU4AMLF-M1	DIODE
D857	MTZJT-775.1C	DIODE
D858	MA165TA5	DIODE
D859	MA165TA5	DIODE
D860	MA165TA5	DIODE
D861	MA165TA5	DIODE
D862	MTZJT-7736A	DIODE
D863	MA165TA5	DIODE
D864	MA165TA5	DIODE
D865	MA165TA5	DIODE
D866	MA165TA5	DIODE
D867	EK06-V0	DIODE
D868	1N4150T-77	DIODE
D869	1N4150T-77	DIODE
D870	MA165TA5	DIODE
D871	1N4150T-77	DIODE
D873	MTZJT-775.6C	DIODE
D874	1SR124-4AT82	DIODE
D875	BZX79A75A26A	DIODE
D901	MA165TA5	DIODE
D902	MA165TA5	DIODE
D904	MA165TA5	DIODE
D905	MA165TA5	DIODE
D906	RLS72TE-11	DIODE
D1061	LN81RPHL	DIODE
D1101	MA165TA5	DIODE
D1102	MA165TA5	DIODE
D2101	MA723TA5	DIODE
D2102	MA723TA5	DIODE
D2103	MA723TA5	DIODE
D2104	MA723TA5	DIODE
D2105	MTZJT-778.2C	DIODE
D2303	MA723TA5	DIODE
D2304	MA723TA5	DIODE
D3201	MTZJT-778.2C	DIODE
D3202	MTZJT-778.2C	DIODE
<b>TRANSISTORS</b>		
Q101	BC847B	TRANSISTOR
Q102	BC847B	TRANSISTOR
Q103	BC847B	TRANSISTOR
Q104	BC847B	TRANSISTOR
Q105	BC847B	TRANSISTOR
Q251	2SD1328STX	TRANSISTOR

Cct Ref	Parts Number	Description
Q252	2SD1328STX	TRANSISTOR
Q253	BC847B	TRANSISTOR
Q254	BC847B	TRANSISTOR
Q301	BC847B	TRANSISTOR
Q302	FMY4T148	TRANSISTOR
Q303	BC847B	TRANSISTOR
Q304	FMY4T148	TRANSISTOR
Q305	BC847B	TRANSISTOR
Q306	FMY4T148	TRANSISTOR
Q351	2SA1767	TRANSISTOR
Q352	2SA1767	TRANSISTOR
Q353	2SA1767	TRANSISTOR
Q354	BC857B	TRANSISTOR
Q451	BC857B	TRANSISTOR
Q503	2SD2398-M2	TRANSISTOR
Q551	BU2508AXLB	TRANSISTOR
Q552	2SC1473-RN	TRANSISTOR
Q701	BC857B	TRANSISTOR
Q850	2SD1273PLB	TRANSISTOR
Q851	BC857B	TRANSISTOR
Q852	2SC1383-S	TRANSISTOR
Q853	BC847B	TRANSISTOR
Q854	BC847B	TRANSISTOR
Q855	BC847B	TRANSISTOR
Q856	BC847B	TRANSISTOR
Q857	2SA1018QTA	TRANSISTOR
Q905	BC847B	TRANSISTOR
Q906	BC847B	TRANSISTOR
Q907	BC857B	TRANSISTOR
Q908	2SA1535ARLB	TRANSISTOR
Q909	2SC3944ARLB	TRANSISTOR
Q950	BC847B	TRANSISTOR
Q951	FMY4T148	TRANSISTOR
Q1051	BC847B	TRANSISTOR
Q1062	BC847B	TRANSISTOR
Q1101	BC847B	TRANSISTOR
Q1104	BC847B	TRANSISTOR
Q1105	BC847B	TRANSISTOR
Q1106	BC847B	TRANSISTOR
Q1107	BC847B	TRANSISTOR
Q1108	BC847B	TRANSISTOR
Q2101	BC857B	TRANSISTOR
Q2102	BC857B	TRANSISTOR
Q2103	BC857B	TRANSISTOR
Q2301	BC847B	TRANSISTOR
Q2302	BC857B	TRANSISTOR
Q2303	BC847B	TRANSISTOR
Q2304	BC857B	TRANSISTOR
Q3001	BC847B	TRANSISTOR
Q3006	BC847B	TRANSISTOR
Q3007	BC847B	TRANSISTOR
Q3201	BC847B	TRANSISTOR
Q3202	BC847B	TRANSISTOR
Q3203	BC857B	TRANSISTOR
Q3204	BC857B	TRANSISTOR
Q3205	BC847B	TRANSISTOR
Q3206	BC847B	TRANSISTOR
Q3207	BC847B	TRANSISTOR
Q3208	BC847B	TRANSISTOR
Q3209	BC847B	TRANSISTOR
Q3401	BC847B	TRANSISTOR
Q3402	BC847B	TRANSISTOR
Q3601	BC847B	TRANSISTOR
<b>TRANSFORMERS</b>		
T501	ETH19Y173AY	TRANSFORMER
T551	ZTFM05002A	F.B.T.



Cct Ref	Parts Number	Description
T801	ETS42AE226AD	TRANSFORMER
T802	ETP35KAN619U	TRANSFORMER
<b>COILS</b>		
J164	TLT331K991R	COIL
J208	EXCELSA35V	COIL
L101	TLT100K991R	COIL
L102	TLT068K991R	COIL
L103	EXCELSA35T	COIL
L104	TLTACT4R7K	COIL
L105	TLTACTR47K	COIL
L106	TLTACT100K	COIL
L107	TLTACT6R8K	COIL
L114	ELJFC2R2KF	COIL
L115	ELJFC2R2KF	COIL
L301	TLTACT4R7K	COIL
L302	TLTACT4R7K	COIL
L451	EXCELSA35T	COIL
L501	EXCELSA35T	COIL
L552	ELH5L6110	COIL
L553	ELC08D682E	COIL
L554	ELC18B102L	COIL
L601	TLTACT4R7K	COIL
L602	TLTACT4R7K	COIL
L603	TLTACT4R7K	COIL
L604	TLTACT4R7K	COIL
L606	TLTACT4R7K	COIL
L607	ELJFC2R2KF	COIL
L701	ELC10D822E	COIL
L850	EXCELSA35T	COIL
L851	EXCELSA35T	COIL
L852	ELEIN470KA	COIL
L853	EXCELSA35T	COIL
L854	EXCELSA35T	COIL
L855	EXCELSA35T	COIL
L856	EXCELSA39V	COIL
L901	EXCELSA24T	COIL
L902	EXCELSA24T	COIL
L1061	TLT331K991R	COIL
L1103	TLTACT100K	COIL
L1104	EXCELSA35T	COIL
L1105	ELJFC2R2KF	COIL
L2101	TLTACT100K	COIL
L2103	EXCELSA35T	COIL
L2104	TLTACT4R7K	COIL
L3001	ELEMV1R5MA	COIL
L3002	ELEMV1R5MA	COIL
L3003	ELEMV1R5MA	COIL
L3004	ELEMV1R5MA	COIL
L3005	ELEBR2R2KA	COIL
L3006	ELEBR2R2KA	COIL
L3007	TLTACT2R2K	COIL
L3201	ELEBR6R8KA	COIL
L3202	ELEBR6R8KA	COIL
L3203	TLT390K991R	COIL
L3401	ELESN2R2KA	COIL
L3402	ELESN2R2KA	COIL
<b>FILTERS</b>		
L804	ELF18N010A	LINE FILTER
X101	EFCT6504BF	FILTER
X102	EFCT7004BF	CERAMIC FILTER
<b>CRYSTALS</b>		
X601	4730007267	CRYSTAL
X1101	TSSA121	CRYSTAL
X2101	4730007158	CRYSTAL

Cct Ref	Parts Number	Description
<b>RESISTORS</b>		
	ERC12GK825	SOLID 0.5W 10% 8M2
JA40	ERJ6GEY0R00	S.M.CARB 0.1W 5% 0
JA15	ERJ6GEY0R00	S.M.CARB 0.1W 5% 0
JA44	ERJ6GEY0R00	S.M.CARB 0.1W 5% 0
JA45	ERJ6GEY0R00	S.M.CARB 0.1W 5% 0
JA14	ERJ6GEY0R00	S.M.CARB 0.1W 5% 0
JA47	ERJ6GEY0R00	S.M.CARB 0.1W 5% 0
JA48	ERJ6GEY0R00	S.M.CARB 0.1W 5% 0
JA49	ERJ6GEY0R00	S.M.CARB 0.1W 5% 0
JA39	ERJ6GEY0R00	S.M.CARB 0.1W 5% 0
JA28	ERJ6GEY0R00	S.M.CARB 0.1W 5% 0
JA1	ERJ6GEY0R00	S.M.CARB 0.1W 5% 0
JA38	ERJ6GEY0R00	S.M.CARB 0.1W 5% 0
JA37	ERJ6GEY0R00	S.M.CARB 0.1W 5% 0
JA36	ERJ6GEY0R00	S.M.CARB 0.1W 5% 0
JA16	ERJ6GEY0R00	S.M.CARB 0.1W 5% 0
JA2	ERJ6GEY0R00	S.M.CARB 0.1W 5% 0
JA13	ERJ6GEY0R00	S.M.CARB 0.1W 5% 0
JA22	ERJ6GEY0R00	S.M.CARB 0.1W 5% 0
JA10	ERJ6GEY0R00	S.M.CARB 0.1W 5% 0
JA27	ERJ6GEY0R00	S.M.CARB 0.1W 5% 0
JA26	ERJ6GEY0R00	S.M.CARB 0.1W 5% 0
JA3	ERJ6GEY0R00	S.M.CARB 0.1W 5% 0
JSE10	ERJ6GEY0R00	S.M.CARB 0.1W 5% 0
JSM7	ERJ6GEY0R00	S.M.CARB 0.1W 5% 0
JSE4	ERJ6GEY0R00	S.M.CARB 0.1W 5% 0
JSE35	ERJ6GEY0R00	S.M.CARB 0.1W 5% 0
JSE33	ERJ6GEY0R00	S.M.CARB 0.1W 5% 0
JSE3	ERJ6GEY0R00	S.M.CARB 0.1W 5% 0
JSE26	ERJ6GEY0R00	S.M.CARB 0.1W 5% 0
JSE25	ERJ6GEY0R00	S.M.CARB 0.1W 5% 0
JSE18	ERJ6GEY0R00	S.M.CARB 0.1W 5% 0
JA57	ERJ6GEY0R00	S.M.CARB 0.1W 5% 0
JSE12	ERJ6GEY0R00	S.M.CARB 0.1W 5% 0
JA12	ERJ6GEY0R00	S.M.CARB 0.1W 5% 0
JA9	ERJ6GEY0R00	S.M.CARB 0.1W 5% 0
JA60	ERJ6GEY0R00	S.M.CARB 0.1W 5% 0
JA58	ERJ6GEY0R00	S.M.CARB 0.1W 5% 0
JA25	ERJ6GEY0R00	S.M.CARB 0.1W 5% 0
JA11	ERJ6GEY0R00	S.M.CARB 0.1W 5% 0
JA55	ERJ6GEY0R00	S.M.CARB 0.1W 5% 0
JA54	ERJ6GEY0R00	S.M.CARB 0.1W 5% 0
JA52	ERJ6GEY0R00	S.M.CARB 0.1W 5% 0
JSE13	ERJ6GEY0R00	S.M.CARB 0.1W 5% 0
JA1	ERJ8GEY0R00	S.M.CARB .125W 5% 0
JA51	ERJ8GEY0R00	S.M.CARB .125W 5% 0
JA2	ERJ8GEY0R00	S.M.CARB .125W 5% 0
JA21	ERJ8GEY0R00	S.M.CARB .125W 5% 0
JA23	ERJ8GEY0R00	S.M.CARB .125W 5% 0
JA29	ERJ8GEY0R00	S.M.CARB .125W 5% 0
JA31	ERJ8GEY0R00	S.M.CARB .125W 5% 0
JA33	ERJ8GEY0R00	S.M.CARB .125W 5% 0
JA34	ERJ8GEY0R00	S.M.CARB .125W 5% 0
JA35	ERJ8GEY0R00	S.M.CARB .125W 5% 0
JA43	ERJ8GEY0R00	S.M.CARB .125W 5% 0
JA46	ERJ8GEY0R00	S.M.CARB .125W 5% 0
JA50	ERJ8GEY0R00	S.M.CARB .125W 5% 0
JA30	ERJ8GEY0R00	S.M.CARB .125W 5% 0
JA56	ERJ8GEY0R00	S.M.CARB .125W 5% 0
JA59	ERJ8GEY0R00	S.M.CARB .125W 5% 0
JA8	ERJ8GEY0R00	S.M.CARB .125W 5% 0
JA5	ERJ8GEY0R00	S.M.CARB .125W 5% 0
JA32	ERJ8GEY0R00	S.M.CARB .125W 5% 0
J116	ERDS1TJ220	CARBON 0.5W 5% 22
R101	ERJ6GEYJ331	S.M.CARB 0.1W 5% 330

Cct Ref	Parts Number	Description				
R102	ERJ6GEYJ103	S.M.CARB	0.1W	5%	10K	🔒
R103	ERJ6GEYJ102	S.M.CARB	0.1W	5%	1K	🔒
R104	ERJ6GEYJ331	S.M.CARB	0.1W	5%	330	🔒
R105	ERJ6GEYJ101	S.M.CARB	0.1W	5%	100	🔒
R106	ERJ6GEYJ680	S.M.CARB	0.1W	5%	68	🔒
R107	ERJ6GEYJ102	S.M.CARB	0.1W	5%	1K	🔒
R108	ERJ6GEYJ103	S.M.CARB	0.1W	5%	10K	🔒
R109	ERJ6GEYJ103	S.M.CARB	0.1W	5%	10K	🔒
R110	ERJ6GEYJ471	S.M.CARB	0.1W	5%	470	🔒
R111	ERJ6GEYJ393	S.M.CARB	0.1W	5%	39K	🔒
R112	ERJ6GEYJ101	S.M.CARB	0.1W	5%	100	🔒
R113	ERJ6GEYJ223	S.M.CARB	0.1W	5%	22K	🔒
R116	ERJ6GEYJ562	S.M.CARB	0.1W	5%	5K6	🔒
R117	ERJ6GEYJ222	S.M.CARB	0.1W	5%	2K2	🔒
R118	ERJ6GEYJ102	S.M.CARB	0.1W	5%	1K	🔒
R121	ERJ6GEYJ471	S.M.CARB	0.1W	5%	470	🔒
R251	ERJ6GEYJ101	S.M.CARB	0.1W	5%	100	🔒
R252	ERJ6GEYJ392	S.M.CARB	0.1W	5%	3K9	🔒
R253	ERJ6GEYJ103	S.M.CARB	0.1W	5%	10K	🔒
R254	ERJ6GEYJ101	S.M.CARB	0.1W	5%	100	🔒
R255	ERJ6GEYJ103	S.M.CARB	0.1W	5%	10K	🔒
R256	ERJ6GEYJ471	S.M.CARB	0.1W	5%	470	🔒
R257	ERJ6GEYJ680	S.M.CARB	0.1W	5%	68	🔒
R258	ERJ6GEYJ392	S.M.CARB	0.1W	5%	3K9	🔒
R259	ERJ6GEYJ680	S.M.CARB	0.1W	5%	68	🔒
R260	ERJ6GEYJ103	S.M.CARB	0.1W	5%	10K	🔒
R261	ERJ6GEYJ471	S.M.CARB	0.1W	5%	470	🔒
R262	ERJ6GEYJ103	S.M.CARB	0.1W	5%	10K	🔒
R263	ERJ6GEYJ473	S.M.CARB	0.1W	5%	47K	🔒
R264	ERJ6GEYJ103	S.M.CARB	0.1W	5%	10K	🔒
R265	ERD25TJ2R2	CARBON	0.25W	5%	2R2	🔒
R266	ERD25TJ2R2	CARBON	0.25W	5%	2R2	🔒
R267	ERF7ZK4R7	WOUND	7W	10%	4R7	🔒 ⚠️
R268	ERJ6GEYJ103	S.M.CARB	0.1W	5%	10K	🔒
R269	ERQ14AJ101	METAL	0.25W	5%	100	🔒 ⚠️
R271	ERJ6GEYJ103	S.M.CARB	0.1W	5%	10K	🔒
R272	ERF7ZK4R7	WOUND	7W	10%	4R7	🔒 ⚠️
R301	ERJ6GEYJ391	S.M.CARB	0.1W	5%	390	🔒
R302	ERJ6GEYJ102	S.M.CARB	0.1W	5%	1K	🔒
R303	ERJ6GEYJ750	S.M.CARB	0.1W	5%	75	🔒
R304	ERJ6GEYJ331	S.M.CARB	0.1W	5%	330	🔒
R305	ERJ6GEYJ391	S.M.CARB	0.1W	5%	390	🔒
R306	ERJ6GEYJ102	S.M.CARB	0.1W	5%	1K	🔒
R307	ERJ6GEYJ750	S.M.CARB	0.1W	5%	75	🔒
R308	ERJ6GEYJ331	S.M.CARB	0.1W	5%	330	🔒
R309	ERJ6GEYJ391	S.M.CARB	0.1W	5%	390	🔒
R310	ERJ6GEYJ102	S.M.CARB	0.1W	5%	1K	🔒
R311	ERJ6GEYJ750	S.M.CARB	0.1W	5%	75	🔒
R312	ERJ6GEYJ331	S.M.CARB	0.1W	5%	330	🔒
R351	ERJ6GEYJ302	S.M.CARB	0.1W	5%	3K	🔒
R352	ERJ6GEYJ302	S.M.CARB	0.1W	5%	3K	🔒
R353	ERJ6GEYJ302	S.M.CARB	0.1W	5%	3K	🔒
R354	ERJ6GEYJ102	S.M.CARB	0.1W	5%	1K	🔒
R355	ERJ6GEYJ102	S.M.CARB	0.1W	5%	1K	🔒
R356	ERJ6GEYJ102	S.M.CARB	0.1W	5%	1K	🔒
R357	ERDS1TJ114	CARBON	0.5W	5%	110K	🔒
R358	ERDS1TJ114	CARBON	0.5W	5%	110K	🔒
R359	ERDS1TJ114	CARBON	0.5W	5%	110K	🔒
R363	ERD25TJ103	CARBON	0.25W	5%	10K	🔒
R364	ERD25TJ103	CARBON	0.25W	5%	10K	🔒
R365	ERD25TJ103	CARBON	0.25W	5%	10K	🔒
R366	ERDS1TJ152	CARBON	0.5W	5%	1K5	🔒
R367	ERDS1TJ152	CARBON	0.5W	5%	1K5	🔒
R368	ERDS1TJ152	CARBON	0.5W	5%	1K5	🔒
R369	ERD25TJ472	CARBON	0.25W	5%	4K7	🔒
R370	ERJ6GEYJ102	S.M.CARB	0.1W	5%	1K	🔒

Cct Ref	Parts Number	Description				
R372	ERQ12AJ121	FUSIBLE	0.5W	5%	120	🔒 ⚠️
R373	ERJ6GEYJ220	S.M.CARB	0.1W	5%	22	🔒
R374	ERD25TJ274	CARBON	0.25W	5%	270K	🔒
R375	ERJ6GEYJ684	S.M.CARB	0.1W	5%	680K	🔒
R376	ERJ6GEYJ183	S.M.CARB	0.1W	5%	18K	🔒
R377	ERQ12HKR22	FUSIBLE	0.5W	5%	R22	🔒 ⚠️
R381	ERJ6GEYJ473	S.M.CARB	0.1W	5%	47K	🔒
R451	ERJ6GEYJ223	S.M.CARB	0.1W	5%	22K	🔒
R452	ERJ6GEY0R00	S.M.CARB	0.1W	5%	0	🔒
R453	ERJ6GEY0R00	S.M.CARB	0.1W	5%	0	🔒
R454	ERJ6GEYJ752	S.M.CARB	0.1W	5%	7K5	🔒
R455	ERJ6GEYJ222	S.M.CARB	0.1W	5%	2K2	🔒
R456	ERJ6GEYJ104	S.M.CARB	0.1W	5%	100K	🔒
R457	ERJ6GEYJ223	S.M.CARB	0.1W	5%	22K	🔒
R458	ERD25TJ1R5	CARBON	0.25W	5%	1R5	🔒
R459	ERJ6GEYJ101	S.M.CARB	0.1W	5%	100	🔒
R460	ERDS1TJ331	CARBON	0.5W	5%	330	🔒
R461	ERW2PK1R2	WOUND	2W	10%	1R2	🔒 ⚠️
R463	ERD25TJ222	CARBON	0.25W	5%	2K2	🔒
R464	ERJ6GEYJ182	S.M.CARB	0.1W	5%	1K8	🔒
R465	ERJ6GEYJ681	S.M.CARB	0.1W	5%	680	🔒
R502	ERJ6GEYJ511	S.M.CARB	0.1W	5%	510	🔒
R506	ERD25TJ560	CARBON	0.25W	5%	56	🔒
R507	ERG1FJ101P	METAL	1W	5%	100	🔒 ⚠️
R509	ERDS1TJ152	CARBON	0.5W	5%	1K5	🔒
R510	ERDS1FJ152	CARBON	0.5W	5%	1K5	🔒 ⚠️
R553	ERG1SJ152	METAL	1W	5%	1K5	🔒
R554	ERG1SJ101	METAL	1W	5%	100	🔒
R555	ERQ12HKR33	METAL	0.5W	5%	R33	🔒 ⚠️
R558	ERDS1TJ124	CARBON	0.5W	5%	120K	🔒
R559	ERQ12HKR33	METAL	0.5W	5%	R33	🔒 ⚠️
R560	ERJ6GEYJ274	S.M.CARB	0.1W	5%	270K	🔒
R561	ERJ6GEYJ273	S.M.CARB	0.1W	5%	27K	🔒
R563	ERJ6GEYJ684	S.M.CARB	0.1W	5%	680K	🔒
R564	ERJ6GEYJ623	S.M.CARB	0.1W	5%	62K	🔒
R566	ERJ6GEYJ563	S.M.CARB	0.1W	5%	56K	🔒
R567	ERF7ZK1R0	WOUND	7W	10%	1	🔒 ⚠️
R601	ERJ6GEYJ101	S.M.CARB	0.1W	5%	100	🔒
R602	ERJ6GEYJ821	S.M.CARB	0.1W	5%	820	🔒
R603	ERJ8GEYJ103	S.M.CARB	.125W	5%	10K	🔒
R604	ERJ6GEYJ101	S.M.CARB	0.1W	5%	100	🔒
R605	ERD25TJ331	CARBON	0.25W	5%	330	🔒
R606	ERD25TJ331	CARBON	0.25W	5%	330	🔒
R607	ERJ6GEYJ821	S.M.CARB	0.1W	5%	820	🔒
R608	ERJ6GEYJ271	S.M.CARB	0.1W	5%	270	🔒
R609	ERJ6GEYJ122	S.M.CARB	0.1W	5%	1K2	🔒
R610	ERJ6GEY0R00	S.M.CARB	0.1W	5%	0	🔒
R611	ERJ6GEYJ103	S.M.CARB	0.1W	5%	10K	🔒
R612	ERJ6GEYJ101	S.M.CARB	0.1W	5%	100	🔒
R613	ERJ6GEYJ152	S.M.CARB	0.1W	5%	1K5	🔒
R622	ERJ6GEY0R00	S.M.CARB	0.1W	5%	0	🔒
R636	ERJ6GEYJ750	S.M.CARB	0.1W	5%	75	🔒
R645	ERJ6GEYJ103	S.M.CARB	0.1W	5%	10K	🔒
R647	ERJ6GEYJ472	S.M.CARB	0.1W	5%	4K7	🔒
R648	ERJ6GEYJ152	S.M.CARB	0.1W	5%	1K5	🔒
R650	ERJ6GEYJ750	S.M.CARB	0.1W	5%	75	🔒
R651	ERJ6GEYJ750	S.M.CARB	0.1W	5%	75	🔒
R652	ERJ6GEYJ102	S.M.CARB	0.1W	5%	1K	🔒
R654	ERJ6GEYJ622	S.M.CARB	0.1W	5%	6K2	🔒
R655	ERJ6GEYJ103	S.M.CARB	0.1W	5%	10K	🔒
R658	ERJ6GEYJ153	S.M.CARB	0.1W	5%	15K	🔒
R659	ERJ6GEY0R00	S.M.CARB	0.1W	5%	0	🔒
R660	ERJ6GEY0R00	S.M.CARB	0.1W	5%	0	🔒
R701	ERQ12AJ101	FUSIBLE	0.5W	5%	100	🔒 ⚠️
R702	ERQ12HJ8R2	FUSIBLE	0.5W	5%	8R2	🔒 ⚠️
R703	ERG2FJ821	METAL	2W	5%	820	🔒 ⚠️

Cct Ref	Parts Number	Description				
R704	ERJ6GEYJ563	S.M.CARB	0.1W	5%	56K	🔧
R705	ERJ6GEYJ104	S.M.CARB	0.1W	5%	100K	🔧
R706	ERJ6GEYJ822	S.M.CARB	0.1W	5%	8K2	🔧
R707	ERJ6GEYJ391	S.M.CARB	0.1W	5%	390	🔧
R708	ERJ6GEYJ393	S.M.CARB	0.1W	5%	39K	🔧
R709	ERJ6GEYJ393	S.M.CARB	0.1W	5%	39K	🔧
R710	ERJ6GEYJ273	S.M.CARB	0.1W	5%	27K	🔧
R711	ERG1SJ101	METAL	1W	5%	100	🔧
R712	ERJ6GEYJ152	S.M.CARB	0.1W	5%	1K5	🔧
R803	ERC12ZGK335D	SOLID	0.5W	10%	3M3	🔧
R805	ERD25TJ473	CARBON	0.25W	5%	47K	🔧
R806	ERD25TJ100	CARBON	0.25W	5%	10	🔧
R807	ERD25TJ332	CARBON	0.25W	5%	3K3	🔧
R809	ERD25TJ681	CARBON	0.25W	5%	680	🔧
R810	ERW2PKR27	WOUND	2W	10%	R27	🔧 ⚠️
R811	ERW2PKR27	WOUND	2W	10%	R27	🔧 ⚠️
R812	ERD75TAJ825	CARBON	0.75W	5%	8M2	🔧 ⚠️
R813	ERF7ZK2R7	WOUND	7W	20%	2R7	🔧 ⚠️
R814	ERD25TJ473	CARBON	0.25W	5%	47K	🔧
R815	ERD25TJ222	CARBON	0.25W	5%	2K2	🔧
R850	ERD25TJ122	CARBON	0.25W	5%	1K2	🔧
R852	ERJ6GEY0R00	S.M.CARB	0.1W	5%	0	🔧
R853	ERJ6GEYJ102	S.M.CARB	0.1W	5%	1K	🔧
R854	ERG2FJ223	METAL	2W	5%	22K	🔧 ⚠️
R855	ERJ6GEYJ752	S.M.CARB	0.1W	5%	7K5	🔧
R856	ERJ6GEYJ752	S.M.CARB	0.1W	5%	7K5	🔧
R857	ERJ6GEYJ752	S.M.CARB	0.1W	5%	7K5	🔧
R858	ERJ6GEYJ752	S.M.CARB	0.1W	5%	7K5	🔧
R859	ERJ6GEYJ753	S.M.CARB	0.1W	5%	75K	🔧
R860	ERQ1CJP2R2	FUSIBLE	1W	10%	2R2	🔧 ⚠️
R861	ERD25TJ221	CARBON	0.25W	5%	220	🔧
R862	ERD25TJ272	CARBON	0.25W	5%	2K7	🔧
R863	ERDS1TJ560	CARBON	0.5W	5%	56	🔧
R864	ERDS1TJ680	CARBON	0.5W	5%	68	🔧
R865	ERJ6GEY0R00	S.M.CARB	0.1W	5%	0	🔧
R867	ERJ6GEYJ103	S.M.CARB	0.1W	5%	10K	🔧
R868	ERJ6GEYJ223	S.M.CARB	0.1W	5%	22K	🔧
R869	ERJ6GEY0R00	S.M.CARB	0.1W	5%	0	🔧
R870	ERJ6GEYJ272	S.M.CARB	0.1W	5%	2K7	🔧
R871	ERJ6GEYJ153	S.M.CARB	0.1W	5%	15K	🔧
R872	ERG1SJ183	METAL	1W	5%	18K	🔧
R873	ERG1SJ223	METAL	1W	5%	22K	🔧
R874	ERD25TJ104	CARBON	0.25W	5%	100K	🔧
R876	ERJ6GEYJ103	S.M.CARB	0.1W	5%	10K	🔧
R877	ERW2PKR47	WOUND	2W	10%	R47	🔧 ⚠️
R878	ERJ6GEYJ473	S.M.CARB	0.1W	5%	47K	🔧
R882	ERG2FJ330H	METAL	2W	5%	33	🔧 ⚠️
R913	ERJ6GEYJ473	S.M.CARB	0.1W	5%	47K	🔧
R914	ERJ6GEYJ822	S.M.CARB	0.1W	5%	8K2	🔧
R915	ERJ6GEYJ152	S.M.CARB	0.1W	5%	1K5	🔧
R916	ERJ6GEYJ391	S.M.CARB	0.1W	5%	390	🔧
R919	ERQ14AJW390	FUSIBLE	0.25W	5%	39	🔧 ⚠️
R920	ERQ14AJW390	FUSIBLE	0.25W	5%	39	🔧 ⚠️
R921	ERD25TJ471	CARBON	0.25W	5%	470	🔧
R922	ERD25TJ393	CARBON	0.25W	5%	39K	🔧
R923	ERD25TJ393	CARBON	0.25W	5%	39K	🔧
R924	ERDS1FJ390	CARBON	0.5W	5%	39	🔧 ⚠️
R925	ERJ6GEY0R00	S.M.CARB	0.1W	5%	0	🔧
R926	ERJ6GEY0R00	S.M.CARB	0.1W	5%	0	🔧
R927	ERD25TJ471	CARBON	0.25W	5%	470	🔧
R928	ERD25TJ5R6	CARBON	0.25W	5%	5R6	🔧
R929	ERDS1FJ471	CARBON	0.5W	5%	470	🔧 ⚠️
R930	ERD25TJ5R6	CARBON	0.25W	5%	5R6	🔧
R931	ERDS1FJ390	CARBON	0.5W	5%	39	🔧 ⚠️
R935	ERQ14AJW3R9	FUSIBLE	0.25W	5%	3R9	🔧 ⚠️
R936	ERQ1CJP331	FUSIBLE	1W	5%	330	🔧 ⚠️

Cct Ref	Parts Number	Description				
R951	ERJ6GEYJ391	S.M.CARB	0.1W	5%	390	🔧
R952	ERJ6GEYJ102	S.M.CARB	0.1W	5%	1K	🔧
R953	ERJ6GEYJ750	S.M.CARB	0.1W	5%	75	🔧
R954	ERJ6GEYJ391	S.M.CARB	0.1W	5%	390	🔧
R1051	ERJ6GEYJ102	S.M.CARB	0.1W	5%	1K	🔧
R1062	ERJ6GEYJ271	S.M.CARB	0.1W	5%	270	🔧
R1063	ERJ6GEYJ103	S.M.CARB	0.1W	5%	10K	🔧
R1101	ERJ6GEYJ101	S.M.CARB	0.1W	5%	100	🔧
R1102	ERJ6GEYJ102	S.M.CARB	0.1W	5%	1K	🔧
R1103	ERJ6GEYJ331	S.M.CARB	0.1W	5%	330	🔧
R1104	ERJ6GEYJ331	S.M.CARB	0.1W	5%	330	🔧
R1105	ERJ6GEYJ101	S.M.CARB	0.1W	5%	100	🔧
R1106	ERJ6GEYJ104	S.M.CARB	0.1W	5%	100K	🔧
R1107	ERJ6GEYJ104	S.M.CARB	0.1W	5%	100K	🔧
R1108	ERJ6GEYJ102	S.M.CARB	0.1W	5%	1K	🔧
R1109	ERJ6GEYJ472	S.M.CARB	0.1W	5%	4K7	🔧
R1110	ERJ6GEYJ472	S.M.CARB	0.1W	5%	4K7	🔧
R1111	ERJ6GEYJ473	S.M.CARB	0.1W	5%	47K	🔧
R1112	ERJ6GEYJ473	S.M.CARB	0.1W	5%	47K	🔧
R1113	ERJ6GEYJ101	S.M.CARB	0.1W	5%	100	🔧
R1115	ERJ6GEYJ471	S.M.CARB	0.1W	5%	470	🔧
R1116	ERJ6GEYJ101	S.M.CARB	0.1W	5%	100	🔧
R1117	ERJ6GEYJ101	S.M.CARB	0.1W	5%	100	🔧
R1118	ERJ6GEYJ472	S.M.CARB	0.1W	5%	4K7	🔧
R1119	ERJ6GEYJ472	S.M.CARB	0.1W	5%	4K7	🔧
R1120	ERJ6GEYJ101	S.M.CARB	0.1W	5%	100	🔧
R1121	ERJ6GEYJ101	S.M.CARB	0.1W	5%	100	🔧
R1123	ERJ6GEYJ101	S.M.CARB	0.1W	5%	100	🔧
R1125	ERJ6GEYJ472	S.M.CARB	0.1W	5%	4K7	🔧
R1126	ERJ6GEYJ101	S.M.CARB	0.1W	5%	100	🔧
R1127	ERJ6GEYJ101	S.M.CARB	0.1W	5%	100	🔧
R1128	ERJ6GEYJ682	S.M.CARB	0.1W	5%	6K8	🔧
R1129	ERJ6GEYJ682	S.M.CARB	0.1W	5%	6K8	🔧
R1130	ERJ6GEYJ103	S.M.CARB	0.1W	5%	10K	🔧
R1131	ERJ6GEYJ103	S.M.CARB	0.1W	5%	10K	🔧
R1132	ERJ6GEYJ101	S.M.CARB	0.1W	5%	100	🔧
R1133	ERJ6GEYJ273	S.M.CARB	0.1W	5%	27K	🔧
R1136	ERJ6GEYJ823	S.M.CARB	0.1W	5%	82K	🔧
R1137	ERJ6GEY0R00	S.M.CARB	0.1W	5%	0	🔧
R1138	ERJ6GEYJ474	S.M.CARB	0.1W	5%	470K	🔧
R1139	ERJ6GEYJ471	S.M.CARB	0.1W	5%	470	🔧
R1140	ERJ6GEYJ471	S.M.CARB	0.1W	5%	470	🔧
R1141	ERJ6GEYJ471	S.M.CARB	0.1W	5%	470	🔧
R1142	ERJ6GEYJ472	S.M.CARB	0.1W	5%	4K7	🔧
R1145	ERJ6GEYJ101	S.M.CARB	0.1W	5%	100	🔧
R1146	ERJ6GEYJ101	S.M.CARB	0.1W	5%	100	🔧
R1147	ERJ6GEYJ101	S.M.CARB	0.1W	5%	100	🔧
R1148	ERJ6GEYJ101	S.M.CARB	0.1W	5%	100	🔧
R1149	ERJ6GEYJ223	S.M.CARB	0.1W	5%	22K	🔧
R1151	ERJ6GEYJ101	S.M.CARB	0.1W	5%	100	🔧
R1152	ERJ6GEYJ101	S.M.CARB	0.1W	5%	100	🔧
R1154	ERJ6GEYJ101	S.M.CARB	0.1W	5%	100	🔧
R1155	ERJ6GEYJ101	S.M.CARB	0.1W	5%	100	🔧
R1156	ERJ6GEYJ101	S.M.CARB	0.1W	5%	100	🔧
R1157	ERJ6GEYJ103	S.M.CARB	0.1W	5%	10K	🔧
R1158	ERJ6GEYJ101	S.M.CARB	0.1W	5%	100	🔧
R1159	ERJ6GEY0R00	S.M.CARB	0.1W	5%	0	🔧
R1160	ERJ6GEYJ223	S.M.CARB	0.1W	5%	22K	🔧
R1161	ERJ6GEYJ103	S.M.CARB	0.1W	5%	10K	🔧
R1167	ERJ6GEYJ100	S.M.CARB	0.1W	5%	10	🔧
R1168	ERJ6GEYJ473	S.M.CARB	0.1W	5%	47K	🔧
R1169	ERJ6GEYJ472	S.M.CARB	0.1W	5%	4K7	🔧
R1170	ERJ6GEYJ273	S.M.CARB	0.1W	5%	27K	🔧
R1171	ERJ6GEYJ224	S.M.CARB	0.1W	5%	220K	🔧
R1172	ERJ6GEYJ223	S.M.CARB	0.1W	5%	22K	🔧
R1173	ERJ6GEYJ104	S.M.CARB	0.1W	5%	100K	🔧

Cct Ref	Parts Number	Description				
R1174	ERJ6GEYJ221	S.M.CARB	0.1W	5%	220	Ω
R1175	ERJ6GEYJ225	S.M.CARB	0.1W	5%	2M2	Ω
R1177	ERD25TJ101	CARBON	0.25W	5%	100	Ω
R1178	ERD25TC0T	CARBON	0.25W	5%	0	Ω
R1251	ERJ6GEYJ222	S.M.CARB	0.1W	5%	2K2	Ω
R1252	ERJ6GEYJ222	S.M.CARB	0.1W	5%	2K2	Ω
R1253	ERJ6GEYJ332	S.M.CARB	0.1W	5%	3K3	Ω
R1254	ERJ6GEYJ512	S.M.CARB	0.1W	5%	5K1	Ω
R1255	ERJ6GEYJ912	S.M.CARB	0.1W	5%	9K1	Ω
R2101	ERJ6GEYJ103	S.M.CARB	0.1W	5%	10K	Ω
R2102	ERJ6GEYJ101	S.M.CARB	0.1W	5%	100	Ω
R2103	ERJ6GEYJ101	S.M.CARB	0.1W	5%	100	Ω
R2104	ERJ6GEYJ101	S.M.CARB	0.1W	5%	100	Ω
R2105	ERJ6GEYJ101	S.M.CARB	0.1W	5%	100	Ω
R2106	ERJ6GEYJ101	S.M.CARB	0.1W	5%	100	Ω
R2107	ERJ6GEYJ101	S.M.CARB	0.1W	5%	100	Ω
R2108	ERJ6GEYJ101	S.M.CARB	0.1W	5%	100	Ω
R2109	ERJ6GEYJ183	S.M.CARB	0.1W	5%	18K	Ω
R2110	ERJ6GEY0R00	S.M.CARB	0.1W	5%	0	Ω
R2111	ERJ6GEYJ221	S.M.CARB	0.1W	5%	220	Ω
R2112	ERJ6GEYJ102	S.M.CARB	0.1W	5%	1K	Ω
R2113	ERJ6GEYJ562	S.M.CARB	0.1W	5%	5K6	Ω
R2114	ERJ6GEYJ101	S.M.CARB	0.1W	5%	100	Ω
R2115	ERJ6GEYJ222	S.M.CARB	0.1W	5%	2K2	Ω
R2116	ERJ6GEYJ101	S.M.CARB	0.1W	5%	100	Ω
R2117	ERJ6GEYJ101	S.M.CARB	0.1W	5%	100	Ω
R2118	ERJ6GEYJ222	S.M.CARB	0.1W	5%	2K2	Ω
R2119	ERJ6GEYJ101	S.M.CARB	0.1W	5%	100	Ω
R2120	ERJ6GEYJ222	S.M.CARB	0.1W	5%	2K2	Ω
R2302	ERJ6GEYJ104	S.M.CARB	0.1W	5%	100K	Ω
R2303	ERJ6GEYJ101	S.M.CARB	0.1W	5%	100	Ω
R2304	ERJ6GEYJ471	S.M.CARB	0.1W	5%	470	Ω
R2305	ERJ6GEYJ102	S.M.CARB	0.1W	5%	1K	Ω
R2306	ERJ6GEYJ103	S.M.CARB	0.1W	5%	10K	Ω
R2308	ERJ6GEYJ104	S.M.CARB	0.1W	5%	100K	Ω
R2309	ERJ6GEYJ101	S.M.CARB	0.1W	5%	100	Ω
R2310	ERJ6GEYJ471	S.M.CARB	0.1W	5%	470	Ω
R2311	ERJ6GEYJ102	S.M.CARB	0.1W	5%	1K	Ω
R2312	ERJ6GEYJ103	S.M.CARB	0.1W	5%	10K	Ω
R3001	ERJ6GEYJ101	S.M.CARB	0.1W	5%	100	Ω
R3002	ERJ6GEYJ471	S.M.CARB	0.1W	5%	470	Ω
R3003	ERJ6GEYJ101	S.M.CARB	0.1W	5%	100	Ω
R3004	ERJ6GEYJ153	S.M.CARB	0.1W	5%	15K	Ω
R3005	ERJ6GEYJ101	S.M.CARB	0.1W	5%	100	Ω
R3006	ERJ6GEYJ471	S.M.CARB	0.1W	5%	470	Ω
R3007	ERJ6GEYJ101	S.M.CARB	0.1W	5%	100	Ω
R3008	ERJ6GEYJ153	S.M.CARB	0.1W	5%	15K	Ω
R3009	ERJ6GEYJ750	S.M.CARB	0.1W	5%	75	Ω
R3010	ERJ6GEYJ750	S.M.CARB	0.1W	5%	75	Ω
R3011	ERJ6GEYJ750	S.M.CARB	0.1W	5%	75	Ω
R3012	ERJ6GEYJ750	S.M.CARB	0.1W	5%	75	Ω
R3013	ERJ6GEYJ101	S.M.CARB	0.1W	5%	100	Ω
R3014	ERJ6GEYJ471	S.M.CARB	0.1W	5%	470	Ω
R3015	ERJ6GEYJ101	S.M.CARB	0.1W	5%	100	Ω
R3016	ERJ6GEYJ153	S.M.CARB	0.1W	5%	15K	Ω
R3017	ERJ6GEYJ101	S.M.CARB	0.1W	5%	100	Ω
R3018	ERJ6GEYJ471	S.M.CARB	0.1W	5%	470	Ω
R3019	ERJ6GEYJ101	S.M.CARB	0.1W	5%	100	Ω
R3020	ERJ6GEYJ153	S.M.CARB	0.1W	5%	15K	Ω
R3021	ERJ6GEYJ750	S.M.CARB	0.1W	5%	75	Ω
R3022	ERJ6GEYJ102	S.M.CARB	0.1W	5%	1K	Ω
R3023	ERJ6GEYJ123	S.M.CARB	0.1W	5%	12K	Ω
R3024	ERJ6GEYJ472	S.M.CARB	0.1W	5%	4K7	Ω
R3025	ERJ6GEYJ750	S.M.CARB	0.1W	5%	75	Ω
R3026	ERJ6GEYJ750	S.M.CARB	0.1W	5%	75	Ω
R3044	ERJ6GEYJ750	S.M.CARB	0.1W	5%	75	Ω

Cct Ref	Parts Number	Description				
R3046	ERJ6GEYJ101	S.M.CARB	0.1W	5%	100	Ω
R3047	ERJ6GEYJ101	S.M.CARB	0.1W	5%	100	Ω
R3048	ERJ6GEYJ103	S.M.CARB	0.1W	5%	10K	Ω
R3049	ERJ6GEYJ101	S.M.CARB	0.1W	5%	100	Ω
R3050	ERJ6GEYJ103	S.M.CARB	0.1W	5%	10K	Ω
R3057	ERJ6GEYJ750	S.M.CARB	0.1W	5%	75	Ω
R3202	ERDS1TJ151	CARBON	0.5W	5%	150	Ω
R3203	ERDS1TJ151	CARBON	0.5W	5%	150	Ω
R3204	ERG2FJ221	METAL	2W	5%	220	Ω
R3205	ERG2FJ221	METAL	2W	5%	220	Ω
R3207	ERJ6GEYJ101	S.M.CARB	0.1W	5%	100	Ω
R3208	ERJ6GEYJ153	S.M.CARB	0.1W	5%	15K	Ω
R3209	ERJ6GEYJ101	S.M.CARB	0.1W	5%	100	Ω
R3210	ERJ6GEYJ153	S.M.CARB	0.1W	5%	15K	Ω
R3211	ERJ6GEYJ223	S.M.CARB	0.1W	5%	22K	Ω
R3212	ERJ6GEYJ223	S.M.CARB	0.1W	5%	22K	Ω
R3213	ERJ6GEYJ102	S.M.CARB	0.1W	5%	1K	Ω
R3214	ERJ6GEYJ683	S.M.CARB	0.1W	5%	68K	Ω
R3215	ERJ6GEYJ302	S.M.CARB	0.1W	5%	3K	Ω
R3216	ERJ6GEYJ750	S.M.CARB	0.1W	5%	75	Ω
R3217	ERJ6GEYJ223	S.M.CARB	0.1W	5%	22K	Ω
R3218	ERJ6GEYJ223	S.M.CARB	0.1W	5%	22K	Ω
R3219	ERJ6GEYJ102	S.M.CARB	0.1W	5%	1K	Ω
R3220	ERJ6GEYJ683	S.M.CARB	0.1W	5%	68K	Ω
R3221	ERJ6GEYJ302	S.M.CARB	0.1W	5%	3K	Ω
R3222	ERJ6GEYJ223	S.M.CARB	0.1W	5%	22K	Ω
R3223	ERJ6GEYJ223	S.M.CARB	0.1W	5%	22K	Ω
R3224	ERJ6GEYJ102	S.M.CARB	0.1W	5%	1K	Ω
R3225	ERJ6GEYJ683	S.M.CARB	0.1W	5%	68K	Ω
R3226	ERJ6GEYJ302	S.M.CARB	0.1W	5%	3K	Ω
R3227	ERJ6GEYJ102	S.M.CARB	0.1W	5%	1K	Ω
R3228	ERJ6GEYJ273	S.M.CARB	0.1W	5%	27K	Ω
R3229	ERJ6GEYJ103	S.M.CARB	0.1W	5%	10K	Ω
R3230	ERJ6GEYJ302	S.M.CARB	0.1W	5%	3K	Ω
R3231	ERJ6GEYJ122	S.M.CARB	0.1W	5%	1K2	Ω
R3232	ERJ6GEYJ242	S.M.CARB	0.1W	5%	2K4	Ω
R3233	ERJ6GEYJ391	S.M.CARB	0.1W	5%	390	Ω
R3234	ERJ6GEYJ102	S.M.CARB	0.1W	5%	1K	Ω
R3402	ERJ6GEYJ750	S.M.CARB	0.1W	5%	75	Ω
R3403	ERJ6GEYJ101	S.M.CARB	0.1W	5%	100	Ω
R3404	ERJ6GEYJ242	S.M.CARB	0.1W	5%	2K4	Ω
R3405	ERJ6GEYJ104	S.M.CARB	0.1W	5%	100K	Ω
R3406	ERJ6GEYJ301	S.M.CARB	0.1W	5%	300	Ω
R3407	ERJ6GEYJ123	S.M.CARB	0.1W	5%	12K	Ω
R3408	ERJ6GEYJ472	S.M.CARB	0.1W	5%	4K7	Ω
R3409	ERJ6GEYJ750	S.M.CARB	0.1W	5%	75	Ω
R3601	ERJ6GEYJ101	S.M.CARB	0.1W	5%	100	Ω
R3602	ERJ6GEYJ101	S.M.CARB	0.1W	5%	100	Ω
R3603	ERJ6GEYJ101	S.M.CARB	0.1W	5%	100	Ω
R3604	ERJ6GEYJ101	S.M.CARB	0.1W	5%	100	Ω
R3605	ERJ6GEYJ101	S.M.CARB	0.1W	5%	100	Ω
R3606	ERJ6GEYJ101	S.M.CARB	0.1W	5%	100	Ω
R3607	ERJ6GEYJ472	S.M.CARB	0.1W	5%	4K7	Ω
R3608	ERJ6GEYJ752	S.M.CARB	0.1W	5%	7K5	Ω
R3609	ERJ6GEY0R00	S.M.CARB	0.1W	5%	0	Ω
R3610	ERJ6GEYJ102	S.M.CARB	0.1W	5%	1K	Ω
R3613	ERJ6GEYJ391	S.M.CARB	0.1W	5%	390	Ω
R3614	ERJ6GEYJ391	S.M.CARB	0.1W	5%	390	Ω
<b>CAPACITORS</b>						
C101	ECJ2VB1C104K	ELECT	350V		100nF	
C102	ECJ2VB1C104K	ELECT	350V		100nF	
C103	ECJ2VF1H104Z	ELECT	350V		100nF	
C104	ECUV1H560JCX	S.M. CAP	50V		56pF	
C105	ECUV1H560JCX	S.M. CAP	50V		56pF	
C106	ECUV1H560JCX	S.M. CAP	50V		56pF	
C107	ECJ2VF1H104Z	ELECT	350V		100nF	

Cct Ref	Parts Number	Description		
C108	ECA1CM470GB	ELECT	16V	47µF
C109	ECUV1H102JCX	S.M. CAP	50V	1nF
C110	ECUV1H103ZFX	S.M. CAP	50V	10nF
C111	ECA1HMR33GB	ELECT	50V	10nF
C114	ECJ2VF1H104Z	ELECT	350V	100nF
C115	ECUV1H103ZFX	S.M. CAP	50V	10nF
C116	ECA1CM221GB	ELECT	16V	220µF
C117	ECUV1H103ZFX	S.M. CAP	50V	10nF
C118	ECJ2VF1H104Z	ELECT	350V	100nF
C119	ECA1CM221GB	ELECT	16V	220µF
C120	ECA1CM221GB	ELECT	16V	220µF
C121	ECUV1H103KBX	S.M. CAP	50V	10nF
C124	ECUV1H220JCX	S.M. CAP	50V	22pF
C125	ECUV1H100DCX	S.M. CAP	50V	10pF
C133	ECUV1H104KBX	S.M. CAP	50V	10pF
C134	ECUV1H104KBX	S.M. CAP	50V	10pF
C135	ECUV1H104KBW	S.M. CAP	50V	10pF
C136	ECUV1H104KBX	S.M. CAP	50V	10pF
C138	ECUV1H104KBX	S.M. CAP	50V	10pF
C251	ECA1EM470GB	ELECT	25V	47µF
C252	ECUV1H223KBX	S.M. CAP	50V	22nF
C253	ECA1HM4R7GB	ELECT	50V	4.7µF
C254	ECQM1H224J	FILM	50V	220nF
C255	ECA1EM101GB	ELECT	25V	100µF
C256	ECUV1H223KBX	S.M. CAP	50V	22nF
C257	ECA1HM4R7GB	ELECT	50V	4.7µF
C258	ECA1EM470GB	ELECT	25V	47µF
C259	ECQM1H224J	FILM	50V	220nF
C260	ECA1VM102GB	ELECT	35V	1nF
C261	ECA1VM102GB	ELECT	35V	1nF
C262	ECQM1H104J	FILM	50V	100nF
C263	ECA1HM010GB	ELECT	50V	1µF
C264	ECA1HHG222E	ELECT	50V	1µF
C265	ECQM1H104J	FILM	50V	100nF
C266	ECA1HM010GB	ELECT	50V	1µF
C267	ECJ2VB1H104K	ELECT	350V	100nF
C268	ECJ2VB1H104K	ELECT	350V	100nF
C270	ECJ2VB1H104K	ELECT	350V	100nF
C301	ECJ2VB1C104K	ELECT	350V	100nF
C302	ECJ2VB1C104K	ELECT	350V	100nF
C303	ECJ2VB1C104K	ELECT	350V	100nF
C304	ECA1CM100GB	ELECT	16V	10µF
C354	ECQM2104KZ	FILM	250V	100nF
C355	ECUV1H471JCX	S.M. CAP	50V	470pF
C356	ECUV1H471JCX	S.M. CAP	50V	470pF
C357	ECUV1H471JCX	S.M. CAP	50V	470pF
C358	ECQM1H224J	FILM	50V	220nF
C360	ECKC3D152J	CERAMIC	2KV	1.5nF
C361	ECA1HMR47GB	ELECT	50V	1.5nF
C363	ECA1VM471GB	ELECT	35V	470µF
C364	ECUV1H103ZFX	S.M. CAP	50V	10nF
C366	ECA1CM100GB	ELECT	16V	10µF
C451	ECUV1H102JX	S.M. CAP	50V	10µF
C453	ECUV1H152KBX	S.M. CAP	50V	10µF
C454	ECUV1H223KBM	S.M. CAP	50V	10µF
C455	ECA1HM100GB	ELECT	50V	10µF
C456	ECA1HHG221B	ELECT	50V	220µF
C458	ECQB1222JF3	FILM	100V	2.2nF
C459	222236516154	FILM	160V	2.2nF
C461	ECCR2H270J	CERAMIC	500V	27pF
C508	ECQV1H105JZ	FILM	50V	1µF
C509	ECEA1HU101	ELECT	50V	100µF
C510	ECUV1H104KBX	S.M. CAP	50V	100µF
C511	ECQM2683JZ	FILM	250V	68nF
C551	ECKC3D152J	CERAMIC	2KV	1.5nF
C552	ECWH15H102JN	FILM	1500V	1.5nF

Cct Ref	Parts Number	Description		
C554	ECWF2H514J	FILM	500V	1.5nF
C555	ECWH15H123JN	CAPACITO	1500V	12nF
C556	ECQF4273JZH	FILM	400V	27nF
C557	ECKC2H471J	CERAMIC	500V	470pF
C558	ECA1HHG471E	ELECT	50V	470µF
C559	ECWF2824JBB	FILM	200V	820nF
C560	ECA2VM010B	ELECT	63V	1µF
C561	ECA1EHG102B	ELECT	25V	1µF
C562	ECKC2H101J	CERAMIC	500V	100pF
C563	ECA2EHG220B	ELECT	250V	20µF
C564	ECEA2AU2R2	ELECT	100V	20µF
C565	ECQP1H273J	FILM	100V	20µF
C566	ECKC2H471J	CERAMIC	500V	470pF
C567	ECA1EHG102B	ELECT	25V	470pF
C568	ECKC2H471J	CERAMIC	500V	470pF
C569	ECKC2H102J	CERAMIC	500V	1nF
C601	ECUV1H104KBX	S.M. CAP	50V	1nF
C602	ECA1HM101GB	ELECT	50V	100µF
C603	ECUV1H102JCX	S.M. CAP	50V	1nF
C604	ECJ2VF1H223Z	ELECT	350V	22nF
C605	ECA1HM101GB	ELECT	50V	100µF
C606	ECA1HM3R3GB	ELECT	50V	3.3µF
C607	ECJ2VF1H104Z	ELECT	350V	100nF
C608	ECUV1H153KBX	S.M. CAP	50V	15nF
C609	ECUV1H153KBX	S.M. CAP	50V	15nF
C610	ECUV1H153KBX	S.M. CAP	50V	15nF
C611	ECUV1H153KBX	S.M. CAP	50V	15nF
C612	ECUV1H153KBX	S.M. CAP	50V	15nF
C613	ECUV1H153KBX	S.M. CAP	50V	15nF
C614	ECUV1H050CCX	S.M. CAP	50V	50pF
C615	ECUV1H050CCX	S.M. CAP	50V	50pF
C616	ECA1CM100GB	ELECT	16V	10µF
C617	ECUV1H223KBX	S.M. CAP	50V	22nF
C618	ECA1CM221GB	ELECT	16V	220µF
C619	ECJ2VB1H473K	ELECT	350V	47nF
C620	ECA1HM101GB	ELECT	50V	100µF
C621	ECJ2VB1C104K	ELECT	350V	100nF
C622	ECUV1H683KBX	S.M. CAP	50V	68nF
C623	ECUV1H102JCX	S.M. CAP	50V	1nF
C624	ECJ3VB1C474K	ELECT	3.5KV	470nF
C625	ECJ3VB1C474K	ELECT	3.5KV	470nF
C626	ECJ3VB1C474K	ELECT	3.5KV	470nF
C627	ECJ3VB1C474K	ELECT	3.5KV	470nF
C628	ECA1CM100GB	ELECT	16V	10µF
C629	ECUV1H104KBX	S.M. CAP	50V	10µF
C630	ECUV1H100DCX	S.M. CAP	50V	10pF
C631	ECUV1H683ZFX	S.M. CAP	50V	68nF
C632	ECUV1H270JCX	S.M. CAP	50V	27pF
C633	ECUV1H271JCX	S.M. CAP	50V	270pF
C634	ECUV1H271JCX	S.M. CAP	50V	270pF
C635	ECUV1H180JCX	S.M. CAP	50V	18pF
C636	ECUV1H271JCX	S.M. CAP	50V	270pF
C637	ECUV1H101JCX	S.M. CAP	50V	100pF
C638	ECUV1H471JCX	S.M. CAP	50V	470pF
C639	ECUV1H332KBM	S.M. CAP	50V	470pF
C701	ECA1HHG101B	ELECT	50V	100µF
C702	ECUV1H103KBX	S.M. CAP	50V	10nF
C703	ECEA1HGE100	ELECT	50V	10µF
C704	ECQB1H223K	FILM	50V	22nF
C705	ECQB1H152K	FILM	50V	1.5nF
C804	ECQE2A474MWB	FILM	100V	470nF
C806	ECKWNA101MBC	CERAMIC	400V	100µF
C807	ECKC2H472J	CERAMIC	500V	4.7nF
C808	ECKC2H472J	CERAMIC	500V	4.7nF
C809	ECKC2H472J	CERAMIC	500V	4.7nF
C810	ECKC2H472J	CERAMIC	500V	4.7nF

Cct Ref	Parts Number	Description			
C811	ECOS2GG181NG	ELECT	400V	180µF	⚠
C814	ECKC3D102J	CERAMIC	2KV	1nF	⚠
C815	ECKC1H471J	CERAMIC	50V	470pF	
C816	EEUFB1E820B	CERAMIC	25V	82pF	
C817	ECQE6104K	FILM	600V	100nF	⚠
C818	ECKWNA332MEC	CERAMIC	250V	3.3nF	
C819	ECQB1H182K	FILM	50V	1.8nF	
C850	ECKC3D471JB	CERAMIC	2KV	470pF	⚠
C851	ECA2CM221E	ELECT	160V	220µF	
C852	ECA2CHG101E	ELECT	160V	100µF	
C853	ECKC2H471J	CERAMIC	500V	470pF	⚠
C854	ECA1EM102GB	ELECT	25V	100µF	
C855	ECKC2H471J	CERAMIC	500V	470pF	⚠
C856	ECA1AHG222B	ELECT	10V	470pF	
C857	ECKC2H471J	CERAMIC	500V	470pF	⚠
C858	ECEA1HGE102	ELECT	50V	470pF	
C859	ECJ2VF1H104Z	ELECT	350V	100nF	
C860	ECA1HM101GB	ELECT	50V	100µF	
C862	ECJ2VF1H104Z	ELECT	350V	100nF	
C863	ECA1HM101GB	ELECT	50V	100µF	
C864	ECJ2VF1H104Z	ELECT	350V	100nF	
C865	ECA1CM100GB	ELECT	16V	10µF	
C866	ECJ2VF1H104Z	ELECT	350V	100nF	
C867	ECA1CM100GB	ELECT	16V	10µF	
C868	ECA1CM100GB	ELECT	16V	10µF	
C869	ECA1EM101GB	ELECT	25V	100µF	
C870	ECA1EM471GB	ELECT	25V	470µF	
C871	ECA1CM102B	ELECT	16V	470µF	
C872	ECA1CM471GB	ELECT	16V	470µF	
C873	ECA1CM100GB	ELECT	16V	10µF	
C875	ECA2CM4R7B	ELECT	160V	10µF	
C876	ECA1HHG101B	ELECT	50V	100µF	
C902	ECA1VM101GB	ELECT	35V	100µF	
C903	ECUV1H472KBX	S.M. CAP	50V	4.7nF	
C904	ECUV1H472KBX	S.M. CAP	50V	4.7nF	
C906	ECUV1H471KBX	S.M. CAP	50V	470pF	
C908	ECUV1H151JCX	S.M. CAP	50V	150pF	
C909	ECKC2H472J	CERAMIC	500V	4.7nF	⚠
C910	ECKC2H472J	CERAMIC	500V	4.7nF	⚠
C911	ECUV1H151JCX	S.M. CAP	50V	150pF	
C912	ECEA2CU100	ELECT	160V	10µF	
C913	ECA1HM101GB	ELECT	50V	100µF	
C914	ECA1HM101GB	ELECT	50V	100µF	
C916	ECEA2CGE100	ELECT	160V	10µF	
C950	ECJ2VB1C104K	ELECT	350V	100nF	
C1061	ECUV1H103KBX	S.M. CAP	50V	10nF	
C1062	ECA1HM101GB	ELECT	50V	100µF	
C1063	ECUV1H331JCX	S.M. CAP	50V	330pF	
C1101	ECJ2VF1H104Z	ELECT	350V	100nF	
C1102	ECA0JM101G	ELECT	6.3V	100µF	
C1103	ECUV1H220JCX	S.M. CAP	50V	22pF	
C1104	ECUV1H220JCX	S.M. CAP	50V	22pF	
C1105	ECUV1H101JCX	S.M. CAP	50V	100pF	
C1108	ECJ2VB1H333K	ELECT	350V	33nF	
C1111	ECA1CM100GB	ELECT	16V	10µF	
C1112	ECUV1H103KBX	S.M. CAP	50V	10nF	
C1115	ECJ3VB1C474K	ELECT	3.5KV	470nF	
C1116	ECUV1H472KBX	S.M. CAP	50V	4.7nF	
C1117	ECJ2VF1H104Z	ELECT	350V	100nF	
C1118	ECUV1H103KBX	S.M. CAP	50V	10nF	
C1119	ECUV1H221JCX	S.M. CAP	50V	220pF	
C1120	ECJ2VF1H104Z	ELECT	350V	100nF	
C1121	ECUV1H221JCX	S.M. CAP	50V	220pF	
C1123	ECUV1H101JCX	S.M. CAP	50V	100pF	
C1124	ECUV1H101JCX	S.M. CAP	50V	100pF	
C1125	ECUV1H101JCX	S.M. CAP	50V	100pF	

Cct Ref	Parts Number	Description			
C1126	ECUV1H101JCX	S.M. CAP	50V	100pF	
C1127	ECUV1H221JCX	S.M. CAP	50V	220pF	
C1128	ECUV1H223KBX	S.M. CAP	50V	22nF	
C1129	ECUV1H270JCX	S.M. CAP	50V	27pF	
C1130	ECA1CM221GB	ELECT	16V	220µF	
C2101	ECUV1H102JCX	S.M. CAP	50V	1nF	
C2102	ECUV1H102JCX	S.M. CAP	50V	1nF	
C2103	ECUV1H102JCX	S.M. CAP	50V	1nF	
C2104	ECUV1H102JCX	S.M. CAP	50V	1nF	
C2105	ECUV1H102JCX	S.M. CAP	50V	1nF	
C2106	ECUV1H102JCX	S.M. CAP	50V	1nF	
C2107	ECUV1H102JCX	S.M. CAP	50V	1nF	
C2108	ECUV1H102JCX	S.M. CAP	50V	1nF	
C2109	ECUV1H102JCX	S.M. CAP	50V	1nF	
C2110	ECUV1H102JCX	S.M. CAP	50V	1nF	
C2111	ECA1CM100GB	ELECT	16V	10µF	
C2112	ECA1CM100GB	ELECT	16V	10µF	
C2113	ECA1HM3R3GB	ELECT	50V	3.3µF	
C2114	ECJ2VF1H104Z	ELECT	350V	100nF	
C2115	ECUV1H221JCX	S.M. CAP	50V	220pF	
C2116	ECUV1H221JCX	S.M. CAP	50V	220pF	
C2117	ECUV1H221JCX	S.M. CAP	50V	220pF	
C2118	ECUV1H221JCX	S.M. CAP	50V	220pF	
C2119	ECUV1H221JCX	S.M. CAP	50V	220pF	
C2120	ECUV1H221JCX	S.M. CAP	50V	220pF	
C2121	ECA1CM100GB	ELECT	16V	10µF	
C2122	ECJ2VF1H104Z	ELECT	350V	100nF	
C2123	ECUV1H221JCX	S.M. CAP	50V	220pF	
C2124	ECUV1H070DTX	S.M. CAP	50V	70pF	
C2125	ECUV1H470JCX	S.M. CAP	50V	47pF	
C2126	ECUV1H070DTX	S.M. CAP	50V	70pF	
C2127	ECUV1H010CCX	S.M. CAP	50V	1pF	
C2128	ECUV1H010CCX	S.M. CAP	50V	1pF	
C2129	ECA1CM102B	ELECT	16V	1pF	
C2130	ECA1CM331B	ELECT	16V	330µF	
C2131	ECUV1H103ZFX	S.M. CAP	50V	10nF	
C2132	ECUV1H103ZFX	S.M. CAP	50V	10nF	
C2133	ECUV1H103ZFX	S.M. CAP	50V	10nF	
C2134	ECUV1H103ZFX	S.M. CAP	50V	10nF	
C2135	ECA1HM101GB	ELECT	50V	100µF	
C2136	ECJ2VF1H104Z	ELECT	350V	100nF	
C2137	ECA1CM100GB	ELECT	16V	10µF	
C2138	ECUV1H471KBX	S.M. CAP	50V	470pF	
C2139	ECUV1H221JCX	S.M. CAP	50V	220pF	
C2140	ECA1HM101GB	ELECT	50V	100µF	
C2141	ECUV1H152JCX	S.M. CAP	50V	1.5pF	
C2301	ECUV1H222JCX	S.M. CAP	50V	2.2nF	
C2302	ECA1CM470GB	ELECT	16V	47µF	
C2303	ECUV1H222JCX	S.M. CAP	50V	2.2nF	
C2304	ECA1CM470GB	ELECT	16V	47µF	
C3001	ECUV1H222JCX	S.M. CAP	50V	2.2nF	
C3002	ECUV1H222JCX	S.M. CAP	50V	2.2nF	
C3003	ECA1CM470GB	ELECT	16V	47µF	
C3005	ECUV1H561JCX	S.M. CAP	50V	560pF	
C3006	ECJ3VB1C474K	ELECT	3.5KV	470nF	
C3007	ECUV1H222JCX	S.M. CAP	50V	2.2nF	
C3008	ECUV1H222JCX	S.M. CAP	50V	2.2nF	
C3009	ECUV1H222JCX	S.M. CAP	50V	2.2nF	
C3010	ECA1CM470GB	ELECT	16V	47µF	
C3012	ECUV1H561JCX	S.M. CAP	50V	560pF	
C3013	ECJ3VB1C474K	ELECT	3.5KV	470nF	
C3014	ECUV1H222JCX	S.M. CAP	50V	2.2nF	
C3015	ECUV1H222JCX	S.M. CAP	50V	2.2nF	
C3016	ECUV1H222JCX	S.M. CAP	50V	2.2nF	
C3017	ECA1CM470GB	ELECT	16V	47µF	
C3019	ECUV1H561JCX	S.M. CAP	50V	560pF	
C3020	ECJ3VB1C474K	ELECT	3.5KV	470nF	

Cct Ref	Parts Number	Description		
C3021	ECUV1H222JCX	S.M. CAP	50V	2.2nF
C3022	ECUV1H222JCX	S.M. CAP	50V	2.2nF
C3023	ECUV1H222JCX	S.M. CAP	50V	2.2nF
C3024	ECA1CM470GB	ELECT	16V	47µF
C3026	ECUV1H561JCX	S.M. CAP	50V	560pF
C3027	ECJ3VB1C474K	ELECT	3.5KV	470nF
C3028	ECUV1H222JCX	S.M. CAP	50V	2.2nF
C3029	ECA1HM101GB	ELECT	50V	100µF
C3032	ECUV1H271JCX	S.M. CAP	50V	270pF
C3033	ECUV1H271JCX	S.M. CAP	50V	270pF
C3034	ECUV1H271JCX	S.M. CAP	50V	270pF
C3035	ECUV1H271JCX	S.M. CAP	50V	270pF
C3101	ECUV1H104KBX	S.M. CAP	50V	270pF
C3102	ECUV1H104KBX	S.M. CAP	50V	270pF
C3111	ECUV1H222KBX	S.M. CAP	50V	2.2nF
C3112	ECUV1H271JCX	S.M. CAP	50V	270pF
C3201	ECUV1H103KBX	S.M. CAP	50V	10nF
C3202	ECUV1H103KBX	S.M. CAP	50V	10nF
C3203	ECUV1H561JCX	S.M. CAP	50V	560pF
C3204	ECUV1H561JCX	S.M. CAP	50V	560pF
C3205	ECA1HM470GB	ELECT	50V	47µF
C3206	ECUV1H561JCX	S.M. CAP	50V	560pF
C3207	ECUV1H561JCX	S.M. CAP	50V	560pF
C3208	ECA1HM470GB	ELECT	50V	47µF
C3209	ECUV1H103KBX	S.M. CAP	50V	10nF
C3210	ECJ2VB1C104K	ELECT	350V	100nF
C3211	ECUV1H103KBX	S.M. CAP	50V	10nF
C3212	ECUV1H103KBX	S.M. CAP	50V	10nF
C3213	ECUV1H103KBX	S.M. CAP	50V	10nF
C3214	ECJ2VB1C104K	ELECT	350V	100nF
C3215	ECUV1H103KBX	S.M. CAP	50V	10nF
C3216	ECA1CM330GB	ELECT	16V	10nF
C3217	ECJ2VB1C104K	ELECT	350V	100nF
C3221	ECA1HM4R7	ELECT	50V	4R7µF
C3401	ECQM1H224J	FILM	50V	220nF
C3402	ECUV1H101JCX	S.M. CAP	50V	100pF
C3403	ECA1HM101GB	ELECT	50V	100µF
C3404	ECQM1H224J	FILM	50V	220nF
C3405	ECUV1H180JCX	S.M. CAP	50V	18pF
C3406	ECUV1H271JCX	S.M. CAP	50V	270pF
C3407	ECUV1H271JCX	S.M. CAP	50V	270pF
C3408	ECA1HM101GB	ELECT	50V	100µF
C3601	ECA1HM101GB	ELECT	50V	100µF
JSE28	ECUV1H104KBX	S.M. CAP	50V	100µF
<b>TERMINALS AND LINKS</b>				
JK2301	JPJ841101320	RCA / HEADPHONE JACK		
JK3201	TJB16656	A.V. TERMINAL		
<b>SWITCHES</b>				
S802	ESB92S11B	SWITCH		
S1251	EVQ23405R	SWITCH		
S1252	EVQ23405R	SWITCH		
S1253	EVQ23405R	SWITCH		
S1254	EVQ23405R	SWITCH		
S1255	EVQ23405R	SWITCH		



Cct Ref	Parts Number	Description
---------	--------------	-------------



# SCHEMA ELETTRICO TX-W28R4F (TELAIO EURO-4)

## IMPORTANTI INFORMAZIONI DI SICUREZZA

I componenti indicati con  hanno caratteristiche speciali ed importante per la sicurezza. Qualora tali componenti vengano sostituiti, devono essere usati solo quelli specificati dal costruttore.

## Nota

- RESISTENZE**  
Tutte le resistenze sono al carbone da 1/8W se sono contrassegnate come segue :  
I valori sono espressi in OHM  $\Omega$  k=1,000 M= 1,000,000.
- CONDENSATORI**  
Tutti i condensatori sono ceramici 50V, se non sono contrassegnati come segue :  
I valori sono espressi in  $\mu$ F, se non diversamente specificato.
- BOBINE**  
I valori sono espressi in  $\mu$ H, se non diversamente specificato.  
Il contrassegno "L" sullo schema elettrico indica la polarità.
- TEST POINT**  
 Posizione dei test point
- MASSA**  
 Massa Linea (Caldo)  
 Massa Telaio (Freddo)
- CONTROLLI DI TENSIONE**  
Le tensioni sono misurate con voltmetro DC alle seguenti condizioni :  

Alimentazione	AC 220-240V, 50Hz
Segnale ricevuto	Segnale a barre colori in (RF)
Controlli dell'utente	Massime regolazioni
- Indica il flusso di segnale principale.  
 VIDEO  
 AUDIO
- Questo schema elettrico è soggetto a variazioni senza preavviso.

## Precauzioni

- Nell'intento di prevenire possibili scosse elettriche evitare di toccare le zone fredde e calde.
- Un corto circuito fra le due sezioni può provocare anomalie nei componenti.
- Nell'utilizzo di uno strumento di misura la massa dello stesso deve essere collegata alla massa del circuito da misurare.
- Le resistenze sotto indicate sono componenti fusibili di sicurezza, e risultano differenziati per valori di corrente.

## Nota

- Nel circuito di alimentazione è presente una sezione le cui tensioni risultano separate dalla massa generale del telaio. Sullo schema elettrico vengono definite aree calda e fredda. Prestare particolare attenzione. Tutti i circuiti escluso quella di alimentazione sono freddi.



Y BOARD  
TNP8EY012

USCITA R. V. B.

IC351  
TDA6103Q/N3

CRT

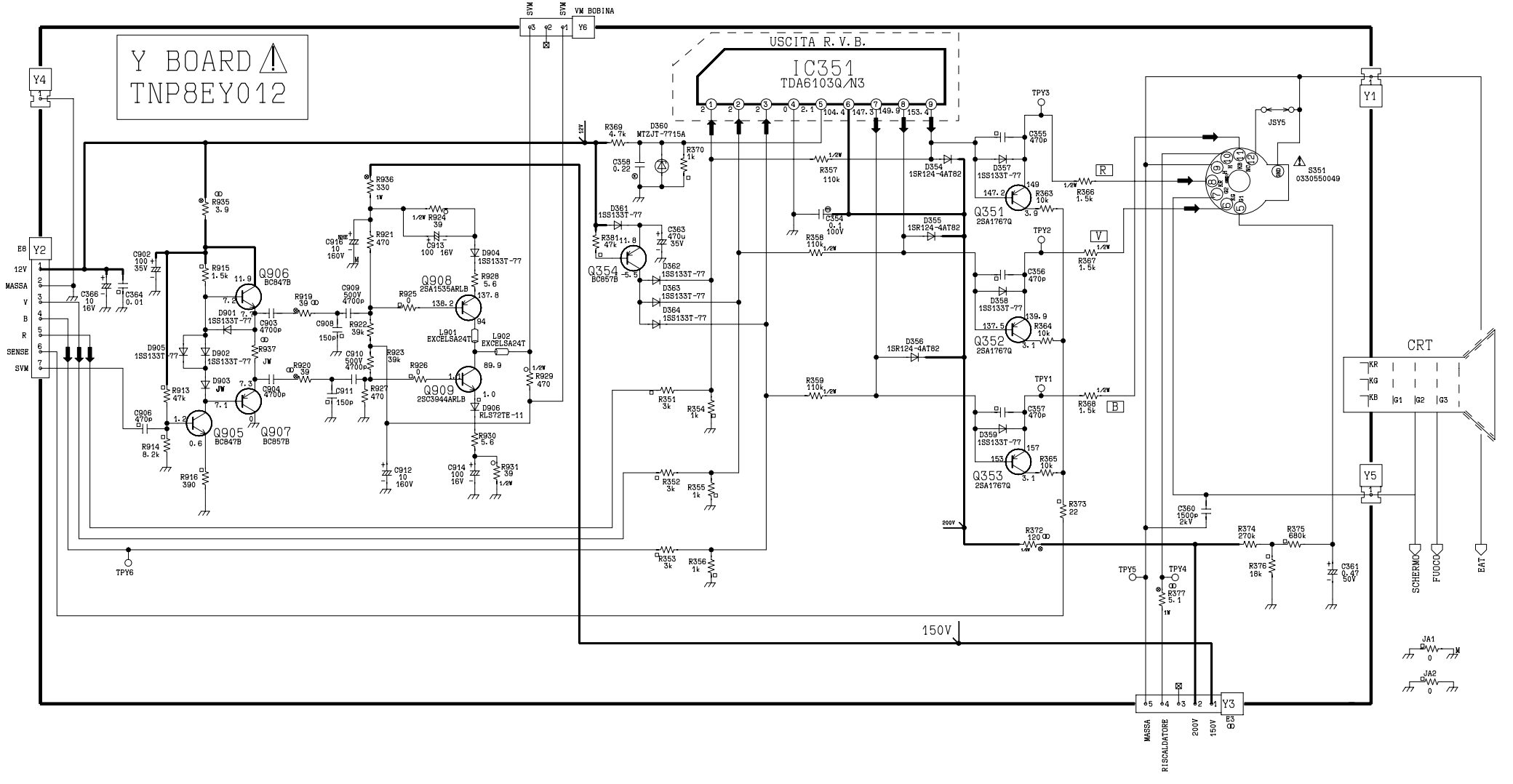

E BOARD  
TNP8EE009

PILOTA R. V. B

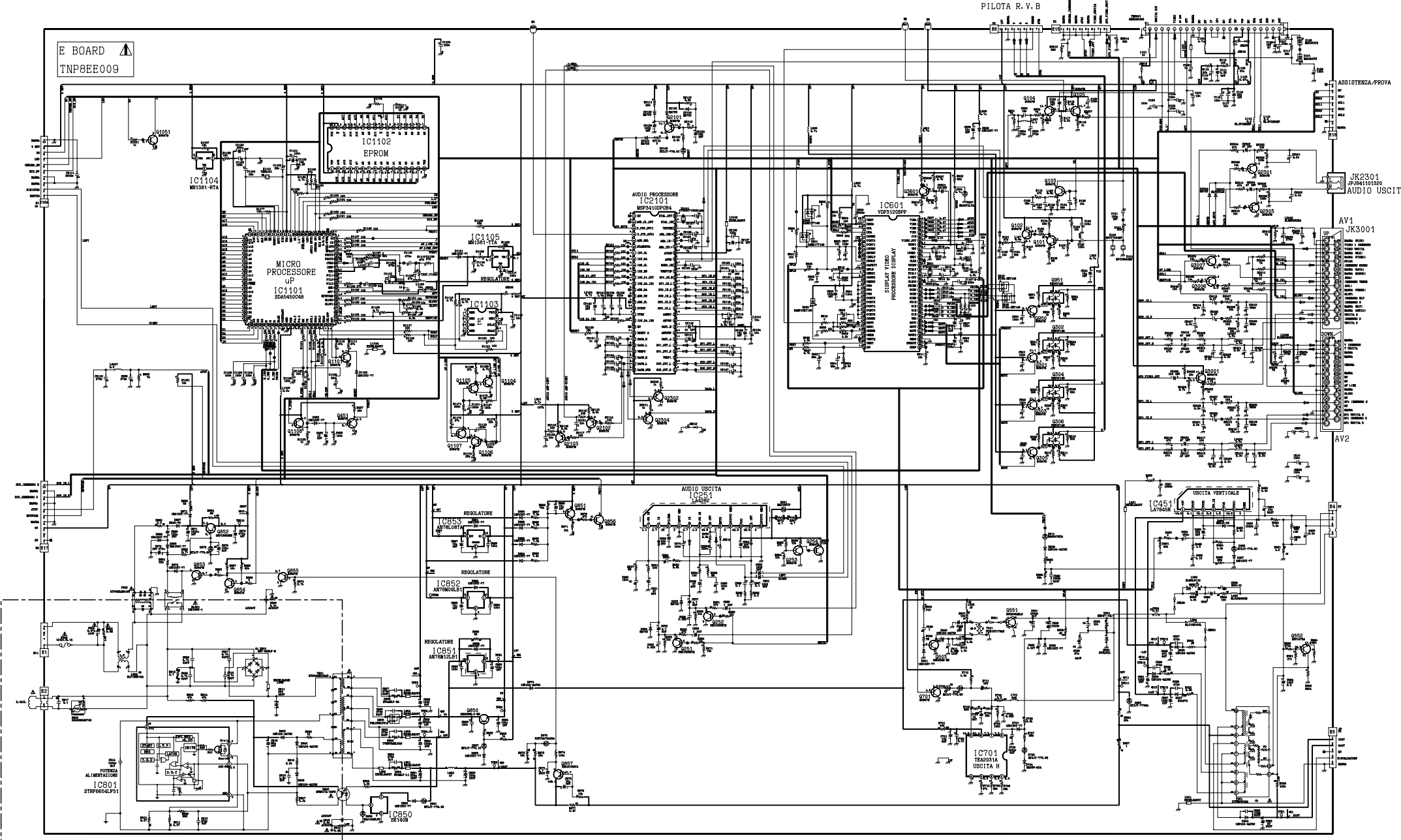

ASSISTENZA-PROVA

JK2501  
AUDIO USCITA

AV1  
JK3001

AV2

IC451  
USCITA VERTICALE

IC701  
TEASOIA  
USCITA H

REGOLATORE  
IC851  
ANTENNALE

REGOLATORE  
IC852  
ANTENNALE

REGOLATORE  
IC853

AUDIO USCITA  
IC251

AUDIO PROCESSORE  
IC2101

IC601  
DISPLAY VIDEO  
PROCESSORE DISPLAY

MICRO  
PROCESSORE  
UP  
IC1101

IC1102  
EPROM

IC1104  
MIC1581-87A

IC1103  
REGULATOR

IC801  
ALIMENTAZIONE  
SERVO

IC850  
SERVO

IC851  
ANTENNALE

IC852  
ANTENNALE

IC853  
REGOLATORE

IC854  
REGOLATORE

IC855  
REGOLATORE

IC1101  
MICRO  
PROCESSORE  
UP

IC1103  
REGULATOR

IC1104  
MIC1581-87A

IC1102  
EPROM

IC1101  
MICRO  
PROCESSORE  
UP

IC1101  
MICRO  
PROCESSORE  
UP

IC1101  
MICRO  
PROCESSORE  
UP

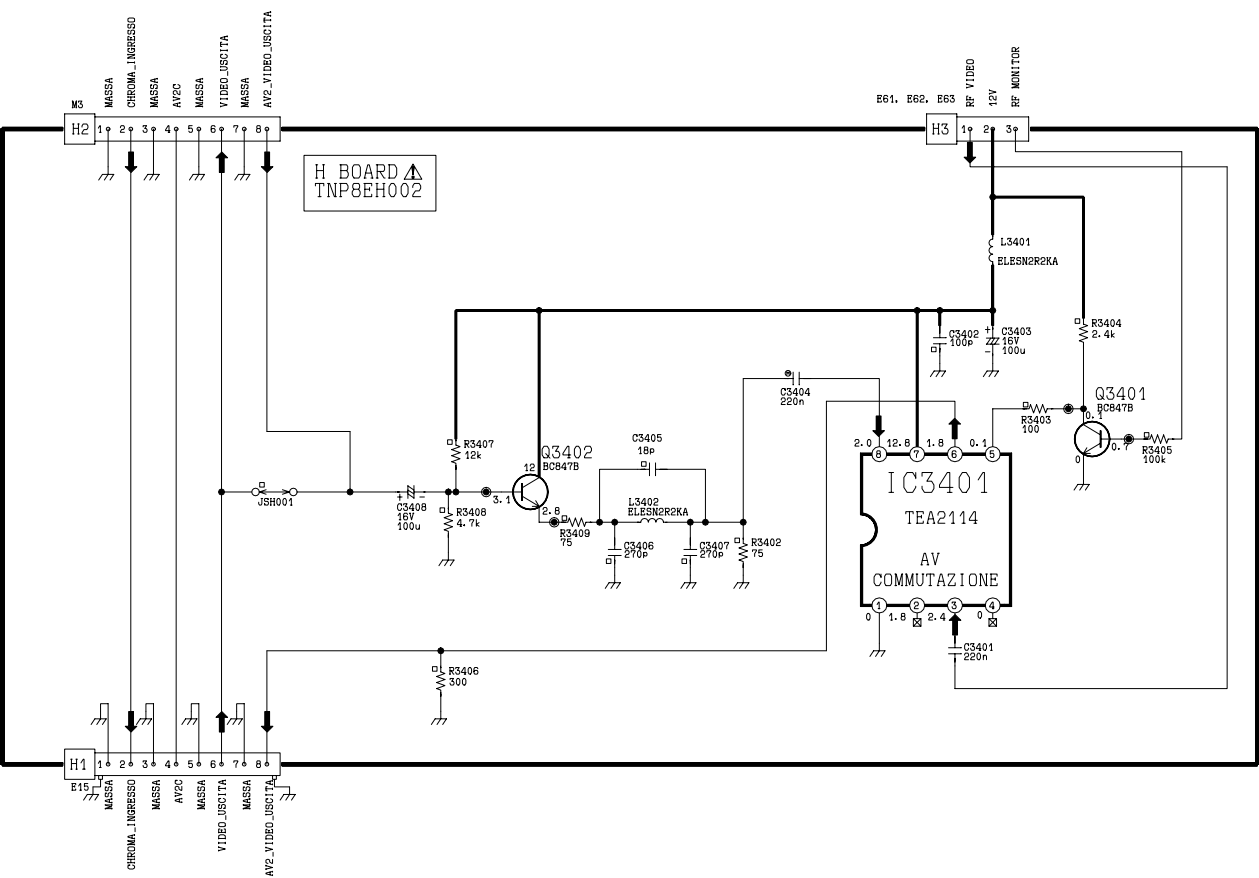





SCHEDA - E TNP8EE009

TRAN'S	DIODES	D558	L4		
Q3601	L8	D3103	B7	D557	M4
Q3007	M9	D3101	B7	D556	K1
Q3001	N8	D3102	B7	D555	N3
Q3006	N10	D2161	G9	D554	M4
Q2304	I7	D2105	G10	D553	K4
Q2303	M6	D2104	F9	D552	J2
Q2301	I7	D2103	G10	D551	K3
Q2103	I8	D2102	G9	D511	M5
Q2102	H8	D1103	F8	D502	I2
Q2101	G10	D1102	F7	D501	I2
Q1108	F9	D1101	G7	D457	L5
Q1107	C7	D1051	A9	D456	L5
Q1106	C7	D875	J5	D454	L5
Q1105	C7	D874	J4	D453	F9
Q1104	C7	D873	B5	D254	C5
Q1101	F7	D871	A5	D253	C5
Q1052	A9	D870	B71	D252	B5
Q1051	C8	D869	B4	D251	B4
Q951	J9	D868	B4	<b>IC'S</b>	
Q950	J9	D867	A3	IC2101	H8
Q857	J4	D866	I9	IC1105	F7
Q856	F9	D865	I9	IC1104	C9
Q855	J5	D864	I10	IC1103	F8
Q854	B4	D863	G9	IC1102	D10
Q853	B4	D862	N10	IC1101	D8
Q852	B5	D861	J9	IC1051	A10
Q850	F5	D860	I10	IC852	I10
Q701	J5	D859	H5	IC851	G5
Q552	N3	D858	E5	IC850	H4
Q551	K1	D857	E5	IC801	G2
Q503	I2	D855	F4	IC701	K5
Q451	F8	D854	G4	IC601	L7
Q394	K9	D853	H3	IC451	L5
Q305	K9	D852	I4	IC251	D6
Q303	K9	D851	I4	<b>TP'S</b>	
Q302	J9	D850	H4	TPE14	M5
Q301	K9	D806	G2	TPE13	M4
Q253	C4	D805	H2	TPE12	K4
Q252	C4	D804	H1	TPE11	N5
Q252	C4	D803	H1	TPE10	B5
Q251	D4	D802	G2	TPE9	E5
Q105	M8	D801	E1	TPE8	F5
Q104	M9	D705	J5	TPE7	I9
Q103	F10	D704	K5	TPE6	J10
Q102	G10	D703	K5	TPE5	G5
Q101	H10	D702	K5	TPE4	G5
		D701	K5	TPE3	E5
		D609	M5	TPE2	I5
		D607	L9	TPE1	M4

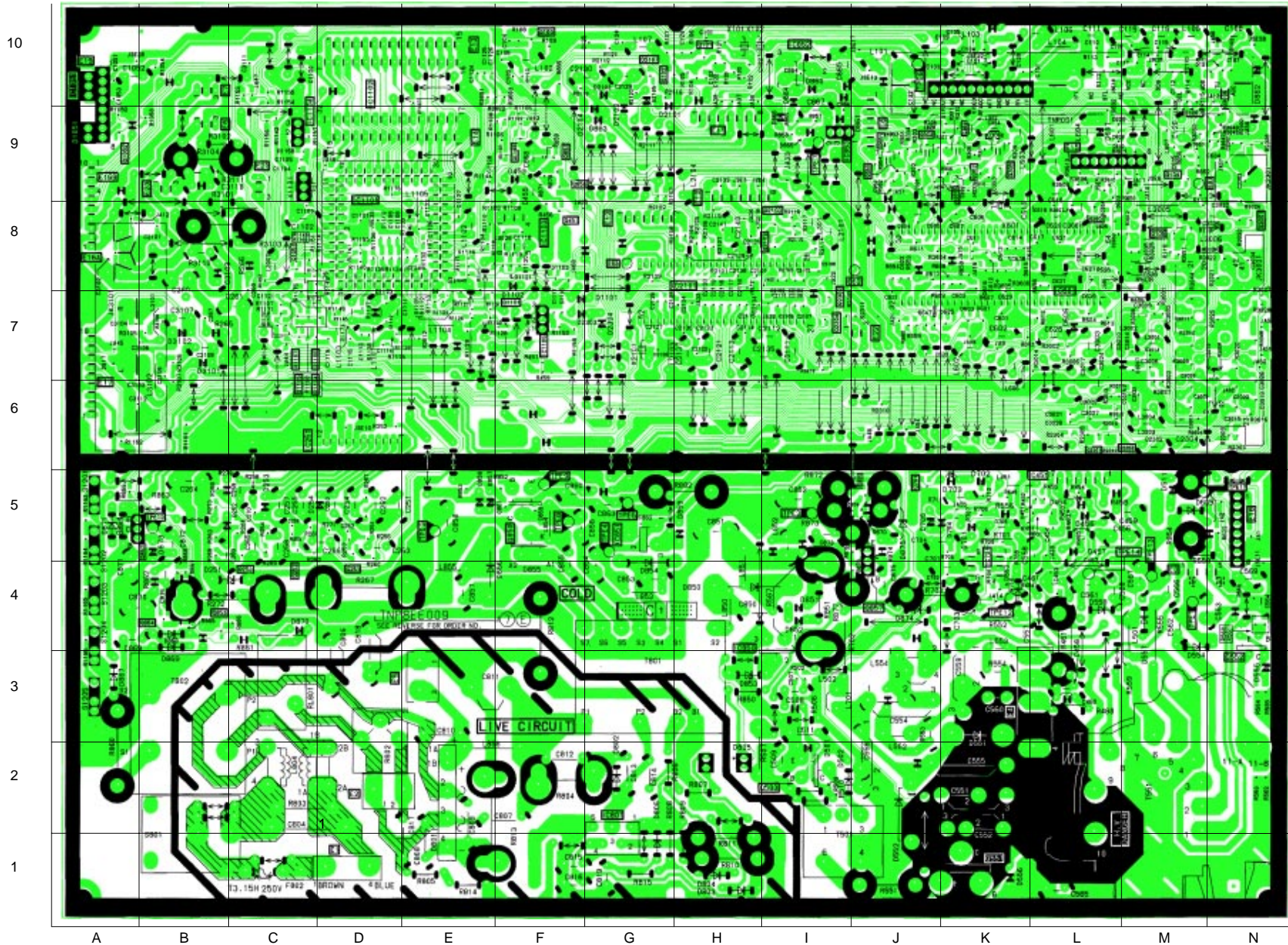



# SCHEDA - Y TNP8EY012

## TRANSISTORS

Q909	E1
Q908	C2
Q907	F4
Q906	G3
Q905	F5
Q354	A7
Q353	G6
Q352	F6
Q351	F6

## DIODES

D906	F1
D905	G4
D904	D3
D902	G4
D901	G3
D364	C9
D363	C8
D362	B9
D361	B7
D360	D8
D359	G6
D358	E7
D357	F7
D356	G7
D355	F7
D354	G7

## TEST POINTS

TPY6	B8
TPY5	D5
TPY4	E5
TPY3	F6
TPY2	E7
TPY1	G6

## IC'S

IC351	E8
-------	----

9  
8  
7  
6  
5  
4  
3  
2  
1

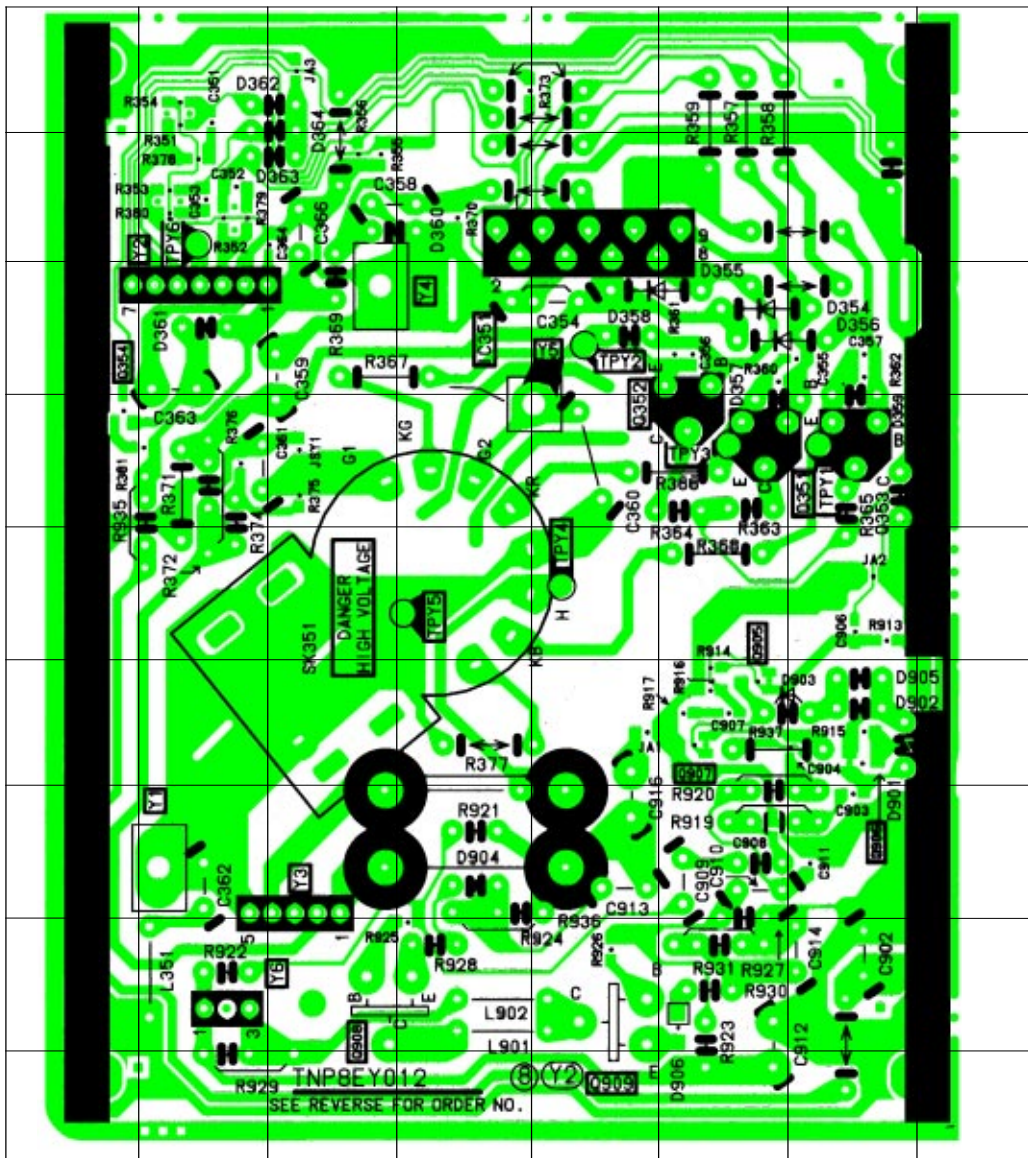

A B C D E F G H

# SCHEDA - M TNP8EM013

TRANSISTORS	
Q1061	C2
Q1062	C2
Q3201	C8
Q3202	B9
Q3203	B8
Q3204	B9
Q3205	B9
Q3206	A9
Q3207	B10
Q3208	B9
Q3209	B10
DIODES	
D1061	C1
D3201	B4
D3202	B4
D3203	B3
IC'S	
IC1601	D2

